

COBALT
46



COBALT YACHTS
OWNER'S MANUAL



We Wish You Safe and Happy Boating!

Your Cobalt boat was built to meet or exceed all applicable boat building standards at the time of manufacture. Your Cobalt boat was inspected and certified prior to introduction, and periodic inspections of this model are conducted in-plant to ensure continued compliance. Cobalt is affiliated with the following organizations for your safety and pleasure.

The American Boat and Yacht Council, Inc. (ABYC) is an independent organization dedicated to developing and maintaining the highest level of marine equipment safety standards for U.S. boat manufacturers. Working closely with the U.S. Coast Guard (USCG) and other authorities, the ABYC reviews marine equipment and systems, including electrical systems, ventilation, steering, flotation, load capacity, fuel system and others that may have an impact on your safety.

The National Marine Manufacturers Association (NMMA) is an independent organization involved in a wide range of activities aimed toward the promotion and improvement of all aspects of boating. Members include manufacturers of boats, engines and marine equipment of all types.

One division of the NMMA provides an inspection and certification program to members. Inspections are performed to the rigid and detailed standards of the USCG and ABYC. Certification requires compliance with all applicable standards and recommendations.



TABLE OF CONTENTS

GENERAL INFORMATION	
WELCOME	1-1
CERTIFICATE OF LIMITED WARRANTY	1-2
INTRODUCTION	1-4
Intended Use	1-4
Craft Design Category	1-4
OWNER RESPONSIBILITY/ WARRANTY PROCEDURE	1-5
Before Operating	1-5
Warranty Service Requirements	1-5
Extended Powertrain Warranty	1-5
If You Sell Your Cobalt Yacht	1-5
CERTIFICATIONS	1-6
NMMA	1-6
FEATURES/CONSTRUCTION	1-6
Amenities	1-6
Construction Standards/Certifications	1-6
Serial Number Locations	1-6
WARNING LABELS	1-7
PUBLICATIONS FOR ONBOARD SYSTEMS	1-9
NAUTICAL TERMS	1-9
SYMBOLS	1-12
SPECIFICATIONS	1-13
LAYOUT	1-14
ALPHABETICAL INDEX	1-15



RESPONSIBILITIES AND SAFETY

OWNER/OPERATOR RESPONSIBILITIES	2-1
Registration/Documentation	2-1
Required Safety Equipment	2-2
Recommended Safety Equipment	2-2
Recommended Spare Parts	2-3
Education Opportunities	2-3
Insurance	2-3
BOAT THEORY	2-3
Remote Control System	2-3
Steering System	2-3
Fuel System	2-4
Ventilation System	2-4
Electrical Systems	2-4
Cooling System	2-4
Exhaust System	2-4
Lubrication System	2-5
Seaworthiness Inspection	2-5
Operation Checklist	2-5
Environmental Considerations	2-5
Components, Maintenance and Repairs	2-7
Emergency Considerations	2-7
Lifesaving Equipment	2-9
SAFETY	2-11
Signal Words/Definitions	2-12
General Safety	2-12
Water Sports Safety	2-18
Navigation	2-20
Aids to Navigation	2-22

OPERATING INFORMATION

PRECAUTIONS	3-1
Before You Start	3-1
Fire/Explosion	3-1
FIRST TIME OPERATION	3-1
FUEL (DIESEL ONLY)	3-2
Fueling	3-2
Launching	3-3
Boarding	3-4
Loading	3-4
Shipshape	3-4
GETTING UNDERWAY	3-4
Before Starting Checklist	3-4
Handling Dock and Mooring Lines	3-5
Starting/Shifting/Steering/Stopping	3-6
Basic Maneuvering	3-11
Entertainment System	3-15
HELM AND INSTRUMENTATION	3-16



CAPTAIN'S CHAIR ADJUSTMENTS AND OPERATION	3-21
SWIM PLATFORM/BOARDING LADDER	3-21
PWC LIFT/SWIM PLATFORM	3-21
COCKPIT DINETTE TABLE	3-22
FOREDECK SUN PAD	3-22
CARBON MONOXIDE DETECTOR	3-22
SPOTLIGHT	3-23
SALON ACCESS DOOR	3-23
ELECTRIC ADJUSTABLE AND EXTENDABLE SALON TABLE - OPTIONAL	3-23
APPLIANCES.....	3-23
WATER/HEATER TANK	3-23
MICROWAVE/COFFEEMAKER	3-24
SALON REFRIGERATOR/FREEZER.....	3-24
COCKPIT REFRIGERATOR.....	3-24
STOVE	3-24
TELEVISION AND ENTERTAINMENT SYSTEMS.....	3-24
CABIN DISTRIBUTION PANEL	3-25
ELECTRICAL	3-25
DC Electrical.....	3-25
AC Electrical.....	3-25
Battery Switches.....	3-26
Shore Power Connection	3-26
Generator	3-27
FRESH WATER	3-28
Water Level Indicator	3-28
MARINE TOILET (HEAD) AND MACERATOR.....	3-28
HEATING, VENTILATION AND AIR CONDITIONING.....	3-29
COCKPIT ENCLOSURE	3-29
TIE DOWN LOCATIONS	3-29
ENGINE HATCH ASSEMBLY	3-30
SYSTEMS	
INTRODUCTION.....	4-1
FUEL ROUTING	4-2
WATER SYSTEM	4-3
Fresh Water, Raw Water, City Waterline	4-3
Waste	4-4
Waste with Gray Water Option.....	4-5
Bilge Layout.....	4-6
Water System.....	4-7
FIRE SUPPRESSION EQUIPMENT.....	4-7
ELECTRICAL SYSTEMS.....	4-7



BATTERY CONNECTIONS	4-8
INTERIOR/EXTERIOR CARE	
VINYL INTERIOR AND UPHOLSTERY	5-1
Care and Cleaning of Vinyl	5-1
Special Cleaning Problems	5-1
CABINETRY AND WOOD	5-3
Cabinetry	5-3
Teak Swim Platform	5-3
Cedar	5-3
CARPET	5-3
DECK AND HULL	5-3
Cleaning Deck and Hull	5-3
Deck and Hull Care	5-4
STAINLESS STEEL AND CHROME	5-4
Preventive Steps	5-4
Cleaning Stainless Steel	5-4
CORROSION PROTECTION	5-5
CorrosionX	5-5
Topside	5-5
Inside the Bulkhead	5-5
Other Areas	5-5
Galvanic Corrosion	5-5
Saltwater	5-6
SUNBRELLA® CANVAS	5-6
Cleaning Canvas	5-6
Special Cleaning Problems	5-7
OTHER CANVAS COMPONENTS	5-7
Clear Vinyl “Strataglass”	5-7
Zippers	5-8
Snap Fasteners	5-8
WINDSHIELD	5-9
BILGE	5-9
MARINE GROWTH	5-9
MAINTENANCE AND TROUBLESHOOTING	
SCHEDULED MAINTENANCE AND SERVICE	6-1
Maintenance Schedule	6-1
Break-In	6-2
Before Each Use	6-2
Every 50 Hours	6-2
Every 100 Hours	6-2
Monthly	6-2
Quarterly	6-3



UNSCCHEDULED MAINTENANCE.....	6-3
Engine/Propulsion/Cooling System	6-3
Electrical System.....	6-3
Fuel System	6-3
Water System.....	6-3
LIFTING THE YACHT	6-4
Using Lifting Slings.....	6-4
Storage Cradle/Stand	6-4
STORAGE/WINTERIZATION	6-5
Reactivating the Yacht After Storage	6-5
TROUBLESHOOTING	6-6
Engine	6-7
Electrical.....	6-8
Plumbing	6-8
REFERENCE AND FORMS	
OPERATION QUICK REFERENCE	7-1
Before Launching	7-1
Pre-Operation.....	7-1
Starting Engines.....	7-2
Casting Off	7-2
During Operation	7-2
Returning to Port	7-2
Stopping the Engines	7-2
After Boating.....	7-2
SERVICE LOG.....	7-3
FUEL LOG	7-4
FLOAT PLAN	7-5
BOAT INFORMATION	7-6



This Page Intentionally Left Blank



GENERAL INFORMATION

WELCOME

Dear New Cobalt Owner,

From all of us at the factory and from your authorized Cobalt dealer, thank you for purchasing a Cobalt boat. We greatly appreciate your business and look forward to a long and enjoyable relationship with you as part of the Cobalt family.

This manual is designed to help you maximize the enjoyment of your Cobalt boat, and to acquaint you with proper operation, care, storage and maintenance of your investment.

Even if you're a seasoned boater and have previously owned a Cobalt boat, I recommend you take time to read through this Owner's manual. As you read this manual, please remember that "common sense" and "courtesy" are the most valuable traits you can have to fully enjoy safe boating. It is also to your personal advantage to become well acquainted with the rules and general "know how" of boating.

For service and for assistance, contact your authorized Cobalt dealer. The dealership staff will be happy to answer questions concerning maintenance, warranty or any other operational questions you may have about your Cobalt boat.

All the best in boating,

Pack St. Clair, Chairman and C.E.O.



CERTIFICATE OF LIMITED WARRANTY

Subject to the terms and conditions in this warranty, Fiberglass Engineering, Incorporated, a Kansas corporation doing business as Cobalt Boats ("Cobalt"), warrants to the original retail purchaser (and any subsequent owner) of a new Cobalt boat purchased from an authorized Cobalt dealer for personal, non-racing and non-commercial use ("Owner"), as follows:

Ten (10) Year Limited Transferable Warranty on Hull and Deck. Cobalt warrants that the hull and deck including floor, stringers, bulkheads, motor mounts, transom and deck/hull joints of a new Cobalt boat are free from structural defects in material and manufacture under normal, non-racing and non-commercial use for a period of ten (10) years from the date of delivery to the original retail purchaser.

Two (2) Year Limited Transferable Warranty on Gelcoat Finish, Upholstery, Components Not Separately Warranted by the Manufacturer and All Components Manufactured by Cobalt Other Than the Hull and Deck. Cobalt warrants that the gelcoat finish, upholstery, components not separately warranted by the manufacturers thereof and all components manufactured by Cobalt with respect to a new Cobalt boat are free from structural defects in material and manufacture under normal, non-racing and non-commercial use for a period of two (2) years from the date of delivery of such Cobalt boat to the original retail purchaser.

THERE ARE NO EXPRESS WARRANTIES OTHER THAN THE ABOVE LIMITED EXPRESS WARRANTIES. IN THE EVENT ANY LAW DOES NOT PERMIT THE DISCLAIMER OF ANY IMPLIED WARRANTY, THEN IN NO EVENT SHALL ANY IMPLIED WARRANTIES, INCLUDING ANY IMPLIED WARRANTIES OF MERCHANTABILITY OR FITNESS FOR PARTICULAR PURPOSE, EXTEND BEYOND THE DURATION OF THESE EXPRESS WRITTEN WARRANTIES.

Some states do not allow limitations on how long an implied warranty lasts, so the above limitation may not apply to you.

Exclusions. The above described limited warranties do not apply if such Cobalt boat has been used at any time commercially, industrially, for racing or other competition or for revenue producing purposes, and also do not apply to: (1) engines, outdrives, propellers, controls, batteries, or other equipment or accessories which are separately warranted by the manufacturers thereof; (2) engines, outdrives, propellers, controls, trailers, equipment or accessories installed by persons or parties other than Cobalt or an authorized Cobalt dealer; (3) windshield leakage, rainwater leakage, windshield or window damage or breakage; (4) deterioration or damage, fading or shrinkage of upholstery, carpet or canvas; (5) damage related to the alteration or modification of such Cobalt boat with any structurally affecting addition, component or accessory not specifically in accordance with Cobalt's specifications or offered as an option by Cobalt; (6) damage or deterioration of gelcoat or other surface finishes, vinyls, fabrics, steel and steel finishes; (7) damage or failures caused by operation of the Cobalt boat outside of the maximum horsepower specifications recommended by Cobalt; (8) damage or failure related to repairs made by any service provider not approved by Cobalt; and (9) damage or failure related to alteration, modification, misuse, neglect, negligence, accident or failure to provide reasonable care and maintenance of such Cobalt boat.

Remedies. During the applicable limited warranty period, as set forth above, covered warranty repairs shall be made without charge by an authorized Cobalt dealer or, at the option of Cobalt, by Cobalt at its plant in Vonore, Tennessee, or at a facility specifically authorized by Cobalt. All warranty repairs shall be subject to the authorization of factory-trained personnel of Cobalt, whose decision shall be final. Transportation to and from an authorized Cobalt dealer, and/or to and from the Cobalt plant in Vonore, Tennessee, for warranty repairs, shall be at Owner's expense. Repair of blisters, when authorized by Cobalt, are covered by this warranty, provided the original factory gelcoat surface has not been altered in any way.



The rights and benefits granted under the above described limited warranty extend to (1) the original retail purchaser of a new Cobalt boat, and (2) any owner of such Cobalt boat during the applicable warranty period, commencing with the date of delivery of such Cobalt boat to the original retail purchaser provided that such limited warranty is validated by such subsequent owner, as set forth herein. **COBALT'S ONLY RESPONSIBILITY, AND THE OWNER'S ONLY REMEDY, IS REPAIR AS DESCRIBED IN THIS WARRANTY. COBALT SHALL NOT BE LIABLE FOR INCIDENTAL, CONSEQUENTIAL, INDIRECT OR SPECIAL DAMAGES.**

Some states do not allow the exclusion or limitation of incidental or consequential damages, so the above exclusions may not apply to you. This warranty gives you specific legal rights, and you may also have other legal rights which vary from state to state.

How to obtain Warranty Service. To validate the above described limited warranty, (1) the original retail purchaser or authorized Cobalt dealer must complete and return the warranty registration card to Cobalt Yachts at 56 Excellence Way, Vonore, TN 37885, within ten (10) days after purchase of any new Cobalt boat covered by such limited warranty, and (2) any subsequent owner of a Cobalt boat during the applicable limited warranty period must give written notice of the acquisition of a Cobalt boat to Cobalt within ten (10) days after such purchase. Notification of any warranty claim arising within the applicable warranty period, as set forth above, must be made in writing by the owner of such Cobalt boat or by an authorized Cobalt dealer to Cobalt within thirty (30) days after the discovery of the alleged basis for any warranty claim.



INTRODUCTION

This manual was created following International Organization for Standards (ISO) 10240:2004 as a guideline. Not all information to conform to the standards set forth by ISO can be included in this manual without certain manufacturer's consent of the equipment included on your boat.

This owner's manual contains information that is necessary to run the boat properly, safety topics, and operation and maintenance hints.

Even if everything has been planned and designed for the safety of the boat and its users, boating is highly dependent on the weather conditions, the sea state, and the experience and physical shape of the crew, and one can never ensure full safety. It is your responsibility as the owner or user to know the boat's equipment, its capabilities and the boat's intended use.

The specific information on the operation of the equipment and systems your boat is supplied with or fitted with should be supplied by that manufacturer. Read, understand and keep all the information supplied, and familiarize yourself and all users with the boat before you put it into use.

All persons should wear a suitable life preserver/personal flotation device when on deck. In some countries it is a legal requirement to wear a suitable life preserver/personal flotation device that complies with those countries' regulations at all times.

WARNING

Avoid serious injury or death.

- **Children, disabled people and non-swimmers should wear a personal flotation device at all times. Children and non-swimmers need special instruction in the use of life preservers. Inform all passengers on the proper use of personal flotation devices and of the location of safety equipment, man overboard recovery equipment and the location and deployment of the ladder.**
- **Avoid contact with any running machinery moving parts, such as an engine, generator or propeller. Contact can result in loss of body parts, strangulation, burns and/or severe loss of blood. Keep all machinery guards in place when machinery is operating.**

Intended Use

Your Cobalt yacht is intended for use as a pleasure craft.

Craft Design Category

Significant Wave Height – is the mean height of the highest one-third of the waves, which approximately corresponds to the wave height estimated by an experienced observer. Some waves will be double this height.

OCEAN – Category A

Craft designed to operate in winds that may exceed wind Beaufort force 8 and in significant wave heights of 13' 1.44" (4 m) and above, and is largely self-sufficient. Abnormal conditions such as hurricanes are excluded. Such conditions may be encountered on extended voyages, for example across oceans, or inshore when unsheltered from the wind and waves for several hundred nautical miles.



OFFSHORE – Category B

Craft designed to operate in winds up to Beaufort force 8 and the associated wave heights and in significant wave heights up to 13' 1.44" (4 m). Such conditions may be encountered on offshore voyages of sufficient length, or on coastal waters when unsheltered from the wind and waves for several dozens of nautical miles. These conditions may also be experienced on inland seas of sufficient size for the wave height to be generated.

INSHORE – Category C

Craft designed to operate in winds up to Beaufort force 6 and the associated wave heights and significant wave heights up to 6' 6.7" (2 m). Such conditions may be encountered in exposed inland waters, in estuaries, and in coastal waters in moderate weather conditions.

SHELTERED WATERS – Category D

Craft designed to operate in winds up to Beaufort force 4 and the associated wave heights (occasional maximum waves of 1' 7.7" [0,5 m] height). Such conditions may be encountered in sheltered inland waters, and in coastal waters in fine weather.

OWNER RESPONSIBILITY/ WARRANTY PROCEDURE

Before Operating

Before operating your new Cobalt boat, it is necessary that you read and understand this manual. Also, take the time to read the other component manuals supplied to you in your owner's packet.

Warranty Service Requirements

All Cobalt warranty service must be completed by an authorized Cobalt dealer. If you are not able to return your boat to your selling dealership, you must contact him so he may assist you in coordinating the warranty repairs. Any claims against Cobalt Boats without prior approval from Cobalt Boats on repairs completed by an unauthorized dealership may be denied.

Extended Powertrain Warranty

Your Cobalt warranty includes an Extended Limited Powertrain Warranty. Your dealer submitted the necessary forms to implement this warranty. Please read the extended warranty manual or contract for specific coverages located in your boat ownership bag.

It is important you have your Cobalt boat serviced per the engine manufacturer's recommended instructions. You must keep, in your possession, records of all service performed should the Extended Powertrain Warranty be needed. This is to prove the required maintenance has been performed. Be sure to collect receipts for work performed and make an entry in the Service Log in the back of this manual.

If you have any questions regarding your Extended Powertrain Warranty, please contact your authorized Cobalt dealer.

If You Sell Your Cobalt Yacht

Your warranties are transferable. If you sell your Cobalt boat to anyone other than an authorized Cobalt dealer, please call Cobalt Yachts for the appropriate warranty transfer information (423-884-4100). If the proper transfer procedures are not followed, future warranty may be denied.

CERTIFICATIONS

NMMA

Cobalt Yachts is a member of the National Marine Manufacturers Association (NMMA). This independent organization's members include boat, engine and marine equipment manufacturers that are focused on the improvement and safety of boating.

Your new Cobalt yacht is NMMA certified. An NMMA certification not only satisfies the U.S. Coast Guard (USCG) regulations but also the more rigorous equipment and system standards based on those established by the American Boat and Yacht Council, Inc. (ABYC). Your Cobalt boat meets or exceeds NMMA safety-based certifications.

Cobalt Yachts has made a significant contribution to the boating industry by successfully completing the Mercury MerCruiser® propulsion-installation quality certification program and the Volvo Penta Certified OEM Program.

FEATURES/CONSTRUCTION

Amenities

Your Cobalt yacht incorporates classic styling with the long, clean lines that have defined Cobalt design for over 40 years.

Performance features of the deck and hull include hand-laid reinforced Kevlar with an all-fiberglass stringer system and AME 1000 vinyl ester resins for superior strength, toughness and weight savings.

Construction Standards/Certifications

A Warranty Statement explaining terms and conditions is supplied in this section. Please familiarize yourself with this statement. Failure to follow operating instructions and proper maintenance can void the warranty.

Construction Standards detailing industry standards followed in building your Cobalt boat are explained in this section. Please contact your authorized Cobalt dealer for additional construction information.

Serial Number Locations

Your Cobalt yacht, its engines and propulsion units, and other equipment onboard will have a serial number for identification. It is a good practice to prepare a list of all serial number items and store it in a safe place other than onboard the boat. A page is supplied at the end of this manual for this purpose. Please refer to the equipment operator's manuals supplied in your owner's packet for location of serial numbers.



WARNING LABELS

The warning labels on your Cobalt boat must remain legible. If a label is damaged or you suspect a label is missing, contact your authorized Cobalt dealer for immediate replacement.

There are several labels used to point out hazards. All of these labels shown may not be included on your boat. The general location of the labels is as follows:

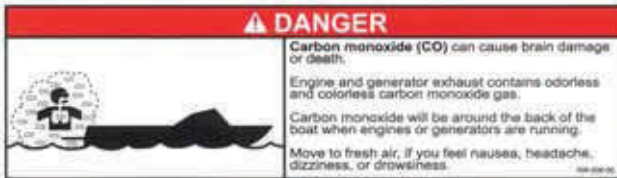

Transom of Boat

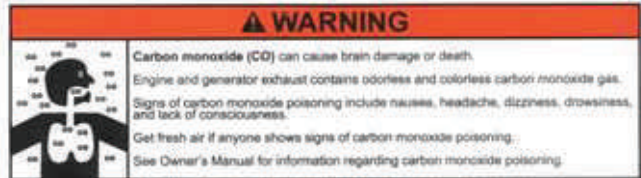

Helm

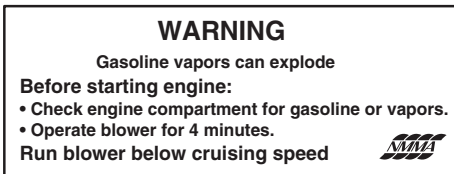

Helm

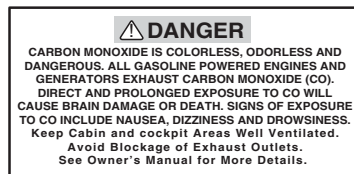

Helm

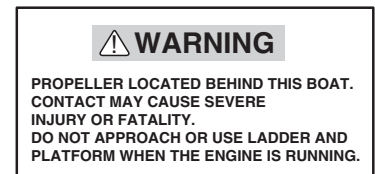

Transom of Boat

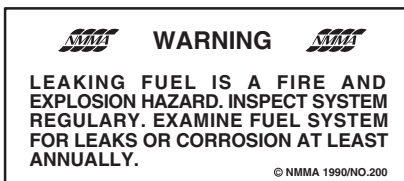

Engine Compartment



Unvented Storage Areas

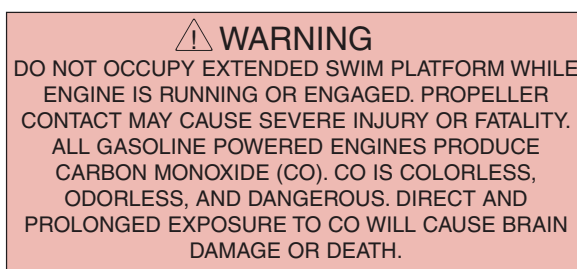

Extended Swim Platform

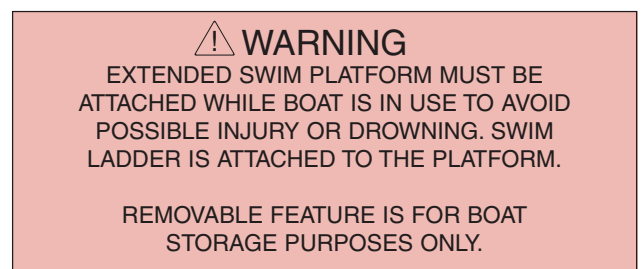

Extended Swim Platform

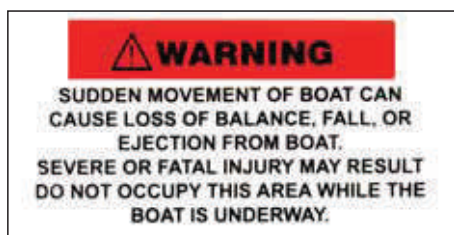

Aft Sun Pad

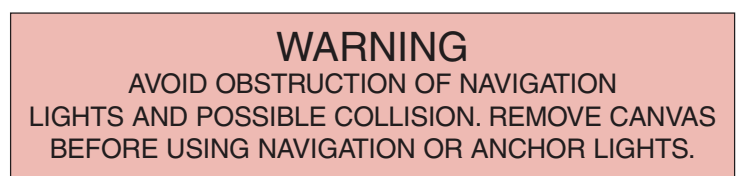

Navigation Light

COB_0018_A



! WARNING
Keep hands and feet away from drive unit when tilting.

Transom of Boat

WARNING!
SECURE DOOR WHEN CRUISING
DO NOT SIT, STAND, OR PLACE HEAVY OBJECTS ON DOOR.
KEEP CABIN DOOR CLOSED WHEN ENGINES OR GENERATOR ARE RUNNING.
DO NOT USE CAUSTIC MATERIALS TO CLEAN.
WASH WITH MILD SOAP AND WATER.

Cabin Door

CAUTION
UNLOCK & REMOVE KEY TO AVOID BREAKING

Cabin Door

CAUTION
TO PREVENT EQUIPMENT DAMAGE
DO NOT OPERATE GENERATOR ABOVE 40 MPH

Engine Compartment, Generator

! WARNING
To minimize shock and fire hazards:
(1) Turn off the boat's shore connection switch before connecting or disconnecting short cable
(2) Connect shore power cable at the boat first.
(3) If polarity warning indicator is activated, immediately disconnect cable.
(4) Disconnect shore power cable at shore outlet first.
(5) Close shore power inlet cover tightly.
DO NOT ALTER SHORE POWER CABLE CONNECTORS

Shore Power Connection

COBALT CHECK LIST
For maximum enjoyment and safety, check each of these items BEFORE you start your engine:
— DRAIN PLUG (securely in Place?)
— LIFE-SAVING DEVICES (One for every person on board?)
— STEERING SYSTEM (Working smoothly and properly?)
— FUEL SYSTEM (Adequate fuel? Leaks? Fumes?)
— BATTERY (Fully charged? Proper water level?)
— ENGINE (In neutral?)
— CAPACITY PLATE (Are you overloaded or overpowered?)
— WEATHER CONDITIONS (Safe to go out)
— ELECTRICAL EQUIPMENT (Lights, horn, pump, etc?)
— EMERGENCY GEAR (Fire extinguisher, bailer, paddle, anchor and line, signalling device, tool kit, etc?)
RECOMMENDED SAFETY RULES
— REMAIN SEATED WHILE UNDERWAY
— AVOID USING REAR PAD OR SUNDECK WHILE ENGINE IS RUNNING
— DO NOT USE BOARDING LADDER WHILE ENGINE IS RUNNING
— TURN OFF ENGINE AND ALL ELECTRICAL SYSTEMS WHILE RE-FUELING
— TURN OFF ENGINE WHEN SWIMMERS ARE NEAR BOAT

Helm

CAUTION TO AVOID INJURY, GLASS DOOR MUST BE SECURED IN A CLOSED AND LOCKED POSITION WHEN BOAT IS UNDER WAY. USE BOTH TURN LOCKS TO SECURE DOOR.

Walk-Through Door/Windshield

! WARNING
A wide variety of components used on this vessel contain or emit chemicals known to the State of California to cause cancer and birth defects and other reproductive harm.
EXAMPLES INCLUDE:
• Engine and generator exhaust
• Engine and generator fuel, and other liquids such as coolants and oil, especially used motor oil.
• Cooking fuels.
• Cleaners, paints, and substances used for vessel repair.
• Waste materials that result from wear of vessel components.
• Lead from battery terminals and from other sources such as ballast or fishing sinkers.
TO AVOID HARM:
• Keep away from engine, generator, and cooking fuel exhaust fumes.
• Wash areas thoroughly with soap and water after handling the substances above.
California Health & Safety Code §§ 25249.5-13

Helm (California Only)

DISCHARGE OF OIL PROHIBITED
THE FEDERAL WATER POLLUTION CONTROL ACT PROHIBITS THE DISCHARGE OF OIL OR WASTE INTO OR UPON THE NAVIGABLE WATER OF THE UNITED STATES OR THE WATERS OF THE CONTIGUOUS ZONE IF SUCH DISCHARGE CAUSES A FILM OR SHEEN UPON OR A DISCOLORATION OF THE SURFACE OF THE WATER OR CAUSE A SLUDGE OR EMULSION BENEATH THE SURFACE OF THE WATER VIOLATORS ARE SUBJECT TO A PENALTY OF \$5000.

Engine Compartment

NMA
YACHT CERTIFICATION
DESIGN COMPLIANCE WITH NMA REQUIREMENTS IN EFFECT ON THE DATE OF CERTIFICATION IS VERIFIED. MANUFACTURER RESPONSIBLE FOR PRODUCTION CONTROL.
NATIONAL MARINE MANUFACTURERS ASSOCIATION
THIS BOAT COMPLIES WITH U.S. COAST GUARD SAFETY STANDARDS IN EFFECT ON THE DATE OF CERTIFICATION
FBRGLS ENG INC, COBALT BT NEODESHA, KS

Helm

COB_0019_A



PUBLICATIONS FOR ONBOARD SYSTEMS

Your owner's packet includes information about onboard systems and equipment furnished by suppliers other than Cobalt Boats. Please refer to these manufacturer's manuals for additional operation and maintenance instructions not covered in this manual.

NAUTICAL TERMS

ABOARD – On or in the boat.

ABYC – American Boat and Yacht Council, Inc.

AFLOAT – On the water.

AFT – Toward the rear or stern of the boat.
Opposite of fore.

AGROUND – Touching bottom.

AMIDSHIP – Center or middle of the boat.

ANCHOR – (1) An iron casting shaped to grip the lake bottom to hold the boat. (2) The act of setting the anchor.

ASHORE – On the shore.

ASTERN – Toward the stern.

BAIL – To remove water from the bottom of the boat with a pump, bucket, sponge, etc.

BEAM – The widest point on the boat.

BEARING – Relative position or direction of an object from the boat.

BILGE – The lowest interior section of the boat hull.

BOARDING – To enter the boat.

BOUNDARY WATERS – A body of water between two areas of jurisdiction; i.e., a river between two states.

BOW – The front of the boat.

BULKHEAD – Vertical partition (wall) in a boat.

BUNKS – Carpeted trailer hull supports.

BURDENED BOAT – Term for the boat that must "give-way" to boats with the right-of-way.

CAPACITY PLATE – A plate that provides maximum weight capacity and engine horsepower rating information. It is located in full view of the helm.

CAPSIZE – To turn over.

CAST-OFF – To unfasten mooring lines in preparation for departure.

CENTER LINE – A lengthwise imaginary line which runs fore and aft with the keel of the boat.

CHINE – The point on a boat where the side intersects (meets) the bottom.

CLEAT – A deck fitting with ears to which lines are fastened.

CONSOLE – Also called helm. The steering wheel area of the boat.

CRANKING BATTERY – The main battery used for engine starting and electrical circuits.

CURRENT – Water moving in a horizontal direction.

DECK – The open surface on the boat where the passengers walk.

DEEP CYCLE BATTERIES – Special long-running batteries which can be repeatedly discharged and recharged without significant loss of power.

DOLLY WHEEL – A rolling jack assembly at the front of the trailer used for positioning the coupler during trailer hookup.

DRAFT – The depth of the boat below the waterline, measured vertically to the lowest part of the hull.

ELECTROLYSIS – The break-up of metals due to the effects of galvanic corrosion.

EPIRB – Emergency Position Indicating Radio Beacon.

FATHOM – Unit of depth or measure; 1 fathom equals 6 feet.



FENDERS – Objects placed alongside the boat for cushioning. Sometimes called bumpers.

FORE – Toward the front or bow of the boat. Opposite of aft.

FREEBOARD – The distance from the water to the gunwale.

FUEL SENDING UNIT – The electrical device that is mounted on the outside of a built-in fuel tank and controls the dashboard fuel gauge.

GIVE-WAY BOAT – (1) Term for the boat that must take whatever action necessary to keep well clear of the boat with the right-of-way in meeting or crossing situations. (2) The burdened boat.

GUNWALE – The rail or upper edge of a boat's side.

HEAD – A marine toilet.

HELM – The steering wheel or command area.

HULL – The body of the boat.

HYPOTHERMIA – A physical condition where the body loses heat faster than it can produce it.

IN-LINE FUSE – A type of protective fuse located in the power wire of a direct current (DC) circuit usually near the battery.

KEEL – The lowest portion of the boat; extends fore and aft along the bottom of the boat.

LIST – Leaning or tilt of a boat toward the side.

LOA – Length overall.

MAKING WAY – Making progress through the water.

MARINE CHART – Seagoing maps showing depths, buoys, navigation aids, etc.

MOORING – An anchor, chain, or similar device that holds a boat in one location.

NAVIGATION AID – Recognizable objects on land or sea such as buoys, towers or lights which are used to fix position to identify safe and unsafe waters.

NMMA – National Marine Manufacturers Association.

NO-WAKE SPEED – The speed at which a boat travels to produce an imperceptible wake.

PFD – Personal Flotation Device.

PITOT TUBE – See SPEEDOMETER PICKUP TUBE.

PLANING HULL – A hull designed to lift, thereby reducing friction and increasing efficiency.

PORPOISE – A condition in which the bow bounces up and down caused by trimming the engine too far out.

PORT – (1) The left side of a boat when facing the bow. (2) A destination or harbor.

PRIVILEGED BOAT – Term used for the boat with the right-of-way.

RIGHT-OF-WAY – Term for the boat that has priority in meeting or crossing situations. The stand on or privileged boat.

RULES OF THE ROAD – Regulations for preventing collisions on the water.

SPEEDOMETER PICKUP TUBE – Also called pitot tube. The plastic device that extends below the bottom of the boat. It connects to the speedometer with plastic flexible tubing.

STAND ON BOAT – Term for the boat that must maintain course and speed in meeting or crossing situations. The privileged boat.

STARBOARD – The right side of the boat when looking toward the bow.

STERN – The back of the boat.

STOW – To pack the cargo.

SURGE BRAKES – A type of trailer braking system designed to automatically actuate when the tow vehicle brakes are applied.

TRANSDUCER – The unit that sends/receives signals for the depth sounder.

TRANSOM – The transverse beam across the stern.



TRIM – Fore to aft and side to side balance of the boat when loaded.

UNDERWAY – Boat in motion; i.e., not moored or anchored.

USCG – United States Coast Guard.

VISUAL DISTRESS SIGNAL – A device used to signal the need for assistance such as flags, lights and flares.

WAKE – The waves that a boat leaves behind when moving through the water.

WATERWAY – A navigable body of water.

WINDLASS – An electric winch to raise the anchor.



SYMBOLS



Light



Filter



Sling Point



Compass

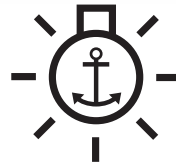

Anchor Lights

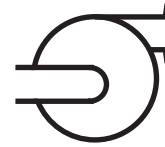

Blower



Boat



Boat Profile

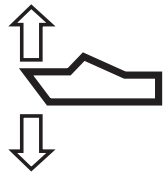

Bow Trim



Do Not Use Water



Draft



Engine Caution



Engine Hour Meter



Engine Key



Engine Stop



Engine



Fuel Tank



Grease



Height Above Water



Holding Tank



Horn



Ignition Switch



Overall Length



Lift Point

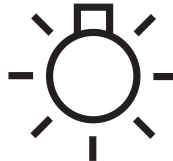

Light

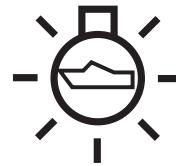

Navigation Lights



Oil

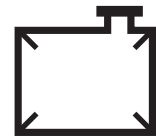

Tank

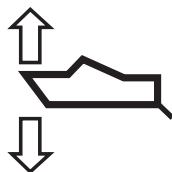

Trim Tabs



Water Tank



Windshield Wipers



Safety Alert Symbol

COB_0030_A



SPECIFICATIONS

Hull Length Overall (LOA)	44' 1-3/4" (13.46 m)
Length Overall (LOA) w/Extended Swim Platform	46' 9-1/2" (14.26 m)
Beam Overall	14' 0" (4.27 m)
Height Overall, w/Electronics and Running Gear	17' 8" (5.38 m)
Height, Bridge Clearance (Waterline to Hardtop)	11' 4" (3.45 m)
Height, Bridge Clearance (Waterline to Mastlight)	13' 8" (4.17 m)
Draft, Zeus	46" (1.17 m)
Draft, V-Drive	48" (1.22 m)
Deadrise at Transom	16°
Dry Weight (can vary with optional equipment)	38,500 lbs (17,500 kg)
Capacity, Fuel	350 gal (1325 L)
Capacity, Water	100 gal (379 L)
Capacity, Waste	50 gal (189 L)
Capacity, Weight	Yacht Certified
Capacity, Persons	Yacht Certified
Water Line	38' (11.58 m)



LAYOUT

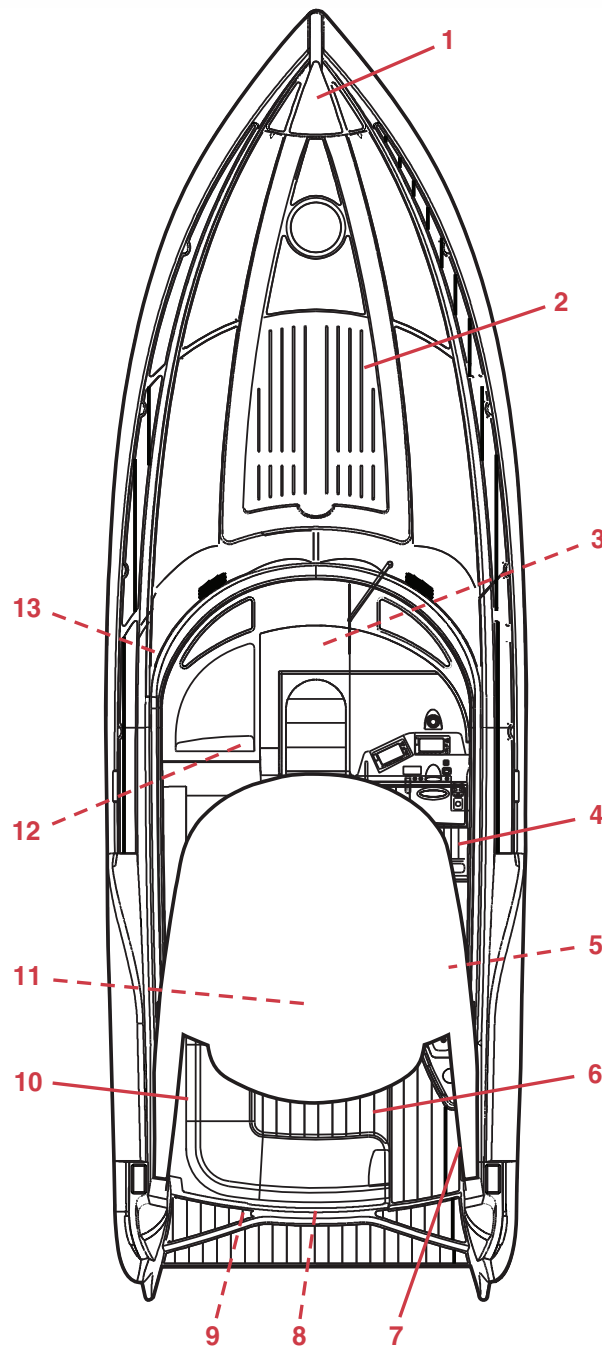

COB_0208_A

- | | |
|---|--|
| 1 – Anchor Locker | 7 – Cockpit E-Plex Switch Panel |
| 2 – Sunpad | 8 – Fender Storage |
| 3 – Freshwater Filters (located in salon floor, fore of the stairs) | 9 – Shore Power and City Water Connections |
| 4 – Helm, Manual Automatic Fire Suppression System, Fire Suppression System Monitor | 10 – Concealed Dinette Table |
| 5 – Cockpit Icemaker, Sink, Trash Receptacle, Optional Barbeque Grill | 11 – Life Raft Storage (located below aft facing cockpit seat) |
| 6 – Day Hatch | 12 – 12-Volt Port, MP3 Auxiliary Port, USB Port (located in glove box) |
| | 13 – E-Plex Menu Panel (located in cabin) |



ALPHABETICAL INDEX

AC Electrical	3-25	Cobalt Check List	3-6
After Boating	7-2	Cockpit Dinette Table	3-22
After Boating:	3-5	Cockpit Enclosure	3-29
After Fueling:	3-3	Cockpit Refrigerator	3-24
Aids to Navigation	2-22	Collisions/Leaks	2-8
Alphabetical Index	1-15	Components, Maintenance and Repairs	2-7
Amenities	1-6	Construction Standards/Certifications	1-6
Anchoring	3-14	Cooling System	2-4
Appliances	3-23	Corrosion Protection	5-5
Approaching a Mooring	3-11	CorrosionX	5-5
Approaching a Slip	3-11	Craft Design Category	1-4
Audible/Visual Distress Signals	2-11	Crossing Situation	2-21
Basic Maneuvering	3-11	Dark Stowage Areas	5-2
Battery Connections	4-8	DC Electrical	3-25
Battery Switches	3-26	Deck and Hull Care	5-4
Before Each Use	6-2	Deck and Hull	5-3
Before Launching	7-1	Discharge of Oil	2-17
Before Operating	1-5	Discharge/Disposal of Waste	2-6
Before Starting Checklist	3-4	Distress Signals	2-9
Before You Start	3-1	Docking	3-10
Bilge Layout	4-6	Drowning	2-9
Bilge	5-9	Drugs/Alcohol	2-14
Boarding	3-4	During Operation	7-2
Boat Information	7-6	During Operation:	3-5
Boat Theory	2-3	Education Opportunities	2-3
Break-In	6-2	Electric Adjustable and Extendable Salon Table - OPTIONAL	3-23
Burdened Boats	2-20	Electrical System	6-3
Cabin Distribution Panel	3-25	Electrical Systems	2-4
Cabinetry and Wood	5-3	Electrical Systems	4-7
Cabinetry	5-3	Electrical	3-25
California Air Resource Board (CARB) Label	2-5	Electrical	6-8
Capacity	2-12	Emergency Considerations	2-7
Captain's Chair Adjustments and Operation	3-21	Emission Control Warranty Information	2-6
Carbon Monoxide Detector	3-22	Engine	6-7
Carbon Monoxide Detectors, if equipped	3-6	Engine Hatch Assembly	3-30
Care and Cleaning of Vinyl	5-1	Engine/Propulsion/Cooling System	6-3
Carpet	5-3	Entertainment System	3-15
Casting Off	7-2	Environmental Considerations	2-5
Cedar	5-3	Every 100 Hours	6-2
Certificate of Limited Warranty	1-2	Every 50 Hours	6-2
Certifications	1-6	Excessive Noise	2-6
Cleaning Agents	2-7	Excessive Noise	2-17
Cleaning Canvas	5-6	Exhaust Emissions	2-7
Cleaning Deck and Hull	5-3	Exhaust System	2-4
Cleaning Stainless Steel	5-4	Extended Powertrain Warranty	1-5
Cleaning	5-8	Features/Construction	1-6
Clear Vinyl "Strataglass"	5-7	Federal, State and Local Regulations	2-17
		Fire Extinguisher	2-2
		Fire Suppression Equipment	4-7



Fire	2-7	Load Distribution	3-12
Fire/Explosion	3-1	Loading.	2-13
First Time Operation	3-1	Loading.	3-4
Fishery Resources.	2-7	Lowering.	3-15
Float Plan.	7-5	Lubrication System.	2-5
Flooding/Swamping	2-8	Maintenance Schedule.	6-1
Foredeck Sun Pad.	3-22	Marine Growth	5-9
Foreign Species.	2-7	Marine Sanitation	2-17
Fresh Water.	3-28	Marine Toilet (Head) and Macerator	3-28
Fresh Water.	6-3	MARPOL Treaty	2-5
Fresh Water, Raw Water, City Waterline.	4-3	Medical Emergency	2-8
Fuel (Diesel Only)	3-2	Meeting Head-On.	2-21
Fuel Log.	7-4	Microwave/Coffeemaker.	3-24
Fuel Routing	4-2	Minor Lights	2-26
Fuel System.	2-4	Monthly.	6-2
Fuel System.	6-3	Mooring Buoys	2-23
Fuel/Spillage	2-5	Nautical Terms	1-9
Fueling.	3-2	Navigation	2-20
Galvanic Corrosion	5-5	Navigation Lights	2-2
General Maintenance	5-7	NMMA	1-6
General Safety.	2-12	OCEAN – Category A	1-4
Generator.	3-27	OFFSHORE – Category B	1-5
Getting Underway	3-4	On the Water	3-3
Grounding	2-8	Operating Conditions	2-13
Handholds	2-12	Operation Checklist	2-5
Handling Dock and Mooring Lines.	3-5	Operation Failure	2-9
Heating, Ventilation and Air Conditioning	3-29	Operation Quick Reference	7-1
Helm and Instrumentation	3-16	Other Areas	5-5
High Speed Operation	3-14	Other Canvas Components	5-7
Horn or Whistle	2-2	Overtaking	2-22
If You Sell Your Cobalt Yacht	1-5	Owner Responsibility/Warranty Procedure	1-5
INSHORE – Category C	1-5	Owner/Operator Responsibilities	2-1
Inside the Bulkhead.	5-5	Paints	2-7
Insurance	2-3	Passengers	2-15
Intended Use	1-4	Personal Flotation Devices	2-9
Introduction	1-4	Platform Dragging (“Teak Surfing”)	2-19
Introduction	4-1	Plumbing	6-8
Isolated Danger Markers	2-26	Precautions	3-1
Lateral Markers	2-24	Pre-Operation.	7-1
Launching Checklist.	3-3	Pre-Operation:	3-4
Launching	3-3	Preventive Steps	5-4
Layout	1-14	Privileged Boats	2-20
Leather Care	5-2	Proposition 65	2-6
Leaving	3-9	Publications for Onboard Systems.	1-9
Life Raft	2-11	PWC Lift/Swim Platform.	3-21
Lifesaving Devices	2-2	Qualified Boat Operators	2-17
Lifesaving Equipment	2-9	Quarterly.	6-3
Lifting the Yacht.	6-4	Radio Communication	2-9
Light Structures	2-26	Range Lights	2-27
Lighthouses	2-27	Reactivating the Yacht After Storage.	6-5



Recommended Cleaning Solutions for PreFixx-Coated Nautolex Vinyls	5-2	Storage Cradle/Stand	6-4
Recommended Safety Equipment	2-2	Storage/Winterization	6-5
Recommended Spare Parts	2-3	Storms	2-8
Registration/Documentation	2-1	Stove	3-24
Regulatory Markers	2-23	Sunbrella® Canvas	5-6
Remote Control System	2-3	Swim Platform/Boarding Ladder	3-21
Rendering Assistance	2-18	Symbols	1-12
Reporting Accidents	2-18	Teak Swim Platform	5-3
Required Safety Equipment	2-2	Techniques	3-11
Returning to Port	7-2	Television and Entertainment Systems	3-24
Returning	3-9	Tie Down Locations	3-29
Safety	2-11	Topside	5-5
Safety While Boating	2-17	Towing	3-15
Salon Access Door	3-23	Trim Tabs	3-13
Salon Refrigerator/Freezer	3-24	Trim	3-12
Saltwater	5-6	Troubleshooting	6-6
Scheduled Maintenance and Service	6-1	Types of Buoys	2-22
Sea Anchors	2-11	Unscheduled Maintenance	6-3
Seating	2-12	Using Lifting Slings	6-4
Seaworthiness Inspection	2-5	Ventilation System	2-4
Serial Number Locations	1-6	Ventilation	2-15
Service Log	7-3	Vinyl Interior and Upholstery	5-1
Setting	3-15	Visibility	2-14
SHELTERED WATERS – Category D	1-5	Visual Distress Signals	2-2
Shifting/Running	3-7	Wake/Wash	2-7
Shipshape	3-4	Wake/Wash	2-18
Shore Power Connection	3-26	Warning Labels	1-7
Signal Words/Definitions	2-12	Warning Markers	2-28
Skill/Experience	2-14	Warranty Service Requirements	1-5
Slow Speed Operation	3-14	Waste	4-4
Snap Fasteners	5-8	Waste Water	6-4
Solid Waste Disposal	2-17	Waste with Gray Water Option	4-5
Special Cleaning Problems	5-1	Water Level Indicator	3-28
Special Cleaning Problems	5-7	Water Rescue (Man Overboard)	2-8
Special Situations	2-22	Water Sports Safety	2-18
Specifications	1-13	Water System	4-3
Spotlight	3-23	Water System	4-7
Stainless Steel and Chrome	5-4	Water System	6-3
Starting Engines	7-2	Water/Heater Tank	3-23
Starting the Engines	3-6	Weather/Seas	2-13
Starting/Shifting/Steering/Stopping	3-6	Weighing	3-15
Steering System	2-3	Welcome	1-1
Steering Wheel	2-4	When Fueling:	3-3
Steering	3-7	Whistle/Horn Signals	2-20
Step 1 Cleaners	5-1	Windshield	5-9
Step 2 Cleaners	5-1	Zeus Propulsion System Operation	3-5
Step 3 Cleaners	5-2	Zippers	5-8
Stopping the Engines	3-9		
Stopping the Engines	7-2		





RESPONSIBILITIES AND SAFETY

Your safety, the safety of your passengers, and other boaters are among your responsibilities as operator of this yacht. Your yacht must be in compliance with U.S. Coast Guard (USCG) safety equipment regulations. You should know how to react correctly to adverse weather conditions, have good navigation skills and follow the “Rules of the Road” as defined by the USCG and state/county/local regulations.

OWNER/OPERATOR RESPONSIBILITIES

At the time of delivery, the owner/operator is responsible for:

- Understanding warranty terms and conditions of the propulsion unit systems and yacht.
- Obtaining insurance.
- Examining yacht to ensure proper operation of all systems.

Before operating the yacht, the owner/operator is responsible for:

- Obtaining state registration of the boat.
- Providing the proper USCG required safety equipment.
- Following proper break-in procedure for the propulsion units.
- Understanding safety information and proper operating procedures within this manual.

While operating the yacht, the owner/operator is responsible for:

- Knowing that all safety equipment and personal flotation devices are in good condition and suitable for your yacht and passenger load.
- Having at least one other passenger who is capable of handling the yacht in an emergency.
- Following safe operating practices and the rules of the road.
- Understanding proper maintenance and knowledge of the operating systems of this yacht.
- Providing safety training for the passengers.
- Avoiding use of alcohol and other drugs.
- Providing assistance to other boaters.

Registration/Documentation

The USCG requires that all power boats operated on the navigable waters of the U.S. must be registered in the state of main use; also, many states require registration in that state whenever boating on waters within their state boundary. Contact your state boating authorities (and neighboring states) for registration information on boats and trailers.

Your authorized Cobalt dealer can supply you with the appropriate forms.

Required Safety Equipment

The Federal Boat Safety Act of 1971 (FBSA/71) established minimum safety standards for boats and associated equipment, specified by the USCG. In addition, the ABYC and the NMMA work with boat builders to develop voluntary standards that exceed base requirements.

The included safety equipment on your Cobalt yacht meets or exceeds the standards of the USCG, ABYC and the NMMA. Some required safety equipment such as personal flotation devices are not included with your Cobalt yacht. Your authorized Cobalt dealer can help you choose the appropriate equipment.



NOTICE: Many states' equipment requirements go beyond USCG requirements. Contact your state boating office for further information. Equipment requirements for coastal and inland waters differ. Check with local authorities or the USCG for further information about coastal water requirements.

Navigation Lights

All power boats underway between sunset and sunrise must display proper navigation lights. All boats at anchor must display a proper anchor light. Anchor light must be visible 360 degrees. Your Cobalt yacht is equipped with international navigation lights.

Horn or Whistle

All boats over 16 ft (4.8 m) in length must be equipped with an operable horn or whistle, audible from one mile. Your Cobalt yacht is equipped with a USCG approved horn.

Fire Extinguisher

All inboard/outboard boats must carry an appropriate portable marine type fire extinguisher in operable condition and accessible location. Your Cobalt yacht is equipped with portable fire extinguishers and a fixed system fire extinguisher.

Lifesaving Devices

All boats must carry one USCG approved Type I, II or III, wearable, personal flotation device, of the proper size, for each person on board. All boats over 16 ft (4.8 m) in length must carry one USCG approved Type IV throwable lifesaving device, such as a ring buoy or buoyant cushion. To meet requirements, each lifesaving device must have a currently legible USCG approval stamp permanently affixed. Your authorized Cobalt dealer can help you select appropriate PFDs and throwable lifesaving devices for your area.

Visual Distress Signals

All boats over 16 ft (4.8 m) must have onboard day and night visual distress signals. Your authorized Cobalt dealer can help you select appropriate visual distress signals for your area.

Recommended Safety Equipment

In spite of all efforts to the contrary, problems or mishaps sometimes occur while boating. Stock these items listed below on your boat to help make unexpected events more manageable.

- Anchor and anchor line
- Compass
- First aid kit
- Distress signals (flag for daytime, flares for darkness)
- Flashlight and spare batteries
- Portable radio
- Cellular phone
- Sea anchor
- Binoculars
- Emergency Position Indicating Radio Beacon (EPIRB)
- Boat hook
- Sun glasses and sun block lotion



Recommended Spare Parts

The following list contains common spare parts you should carry onboard. Review all the equipment on your yacht. Be sure to have spare parts available to maintain and make minor repairs if necessary. Refer to all operator's manuals in your owner's packet for the manufacturer's recommended spare parts.

- Engine and generator oil
- Hydraulic fluid for the steering system and trim system
- Ignition keys
- Tape, tie straps and rope
- Light bulbs and fuses
- Propeller with attaching hardware

Education Opportunities

Be boat smart from the start, take a boating safety course and get a free vessel safety check annually for your yacht. For more information, contact: United States Coast Guard Auxiliary, www.cgaux.org; United States Power Squadrons, 888-FOR-USPS, www.usps.org. Most boaters can enhance their enjoyment of boating experiences through increased knowledge of safe operation, navigation and regulation of pleasure boats. The following is a list of some other agencies and organizations that offer Water Safety, First Aid and CPR courses or information.

To find boating safety courses in your area, call your state's local boating agency or the USCG boating safety course line at 800-336-2628 (800-245-2628 in Virginia).

- American Red Cross
- U.S. Coast Guard Auxiliary
- U.S. Power Squadrons
- State Boating Offices
- Canadian Power and Sail Squadrons
- Yacht Clubs

Insurance

You must get insurance before operating your new boat. Insurance for loss by fire, theft or other causes, or liability protection against accidents is a must for responsible boaters. The boat owner is legally responsible for any damage or injury caused when the owner or someone else operating the boat is involved in an accident. Many states have laws detailing minimum insurance needs. Your insurance agent or your dealer may be able to supply you with more information.

BOAT THEORY

The following information briefly explains main system theory.

Remote Control System

The shift/throttle levers are connected to the engine and propulsion units electronically. The levers control the direction and the speed of the boat.

Steering System

Zeus Propulsion System - Your yacht is equipped with a joystick control, linked with computers and software to control the engines, direction of the yacht and its speed. The joystick control and electronic controls are primarily for low-speed maneuvering in tight spaces. The steerable pods of the Zeus system, along with an advanced joystick control system, deliver precise turning and tight maneuvering that is far superior to bow thrusters.

The optional Skyhook feature, a component of the Precision Pilot™ system, keeps a Zeus-equipped yacht within a tight area or on a fixed heading.



⚠ WARNING

ASK THE CAPTAIN BEFORE ENTERING THE WATER.

This boat has a feature called Skyhook, which automatically holds the boat in position.

When Skyhook is activated:

- **the propellers rotate automatically.**
- **propeller rotation may not be obvious.**
- **the boat may suddenly move in any direction.**
- **the propellers can injure people in the water anywhere around the boat.**

Unless the Captain gives you permission:

- **do not go in the water; wind or water current can move swimmers into the propellers.**
- **do not sit or stand where you could fall overboard; you may lose your balance if the boat moves suddenly.**

A gentle twist of the joystick allows you to make a 360 degree turn. Push the joystick in any direction, forward, backward, diagonal and even sideways and the yacht will follow the command. Refer to the Zeus propulsion operator's manual for more detailed operation of the system.

Steering Wheel

The steering wheel uses the assistance of power steering, which allows you to turn the steering wheel with minimum effort. It is very important that you know how your steering affects the operation of your yacht and be aware of its limitations.

Fuel System

The fuel system consists of permanent tanks with an air vent system, fuel level sensors and fuel fill components. In case of a fuel leak or fire, both tanks have shutoff valves. The entire fuel system can be filled from either the port or starboard fill fitting provided the crossover valve is left in the open position (See Systems Summary, page 4).

Ventilation System

The engine compartment ventilation system consists of blowers installed in the engine compartment. These blowers come on automatically with engine ignition or can be activated by switch.

Electrical Systems

Your Cobalt yacht is equipped with two electrical systems. A direct current (DC) system is battery powered and supplies electricity to lights, pumps, blowers, engine ignition and sometimes a refrigerator. An alternating current (AC) system is shore power, or generator, and supplies electricity to the electrical outlet, air conditioning, battery charger and other 110V AC or 220V AC appliances or components.

Cooling System

The engines and generator are cooled by the continuous intake of raw water through independent water intakes. The water flows to water pumps on the engines and/or generator for circulation around internal components. The engine water intakes and outlets are located in the propulsion system on Zeus-equipped yachts, while inboard, V-drive yachts and the generator water intakes are located in the bottom of the hull. The air conditioner intake is also in the bottom of the hull and exits from the side. If your Cobalt yacht is equipped with a self-contained cooling system, a mixture of fresh water and antifreeze is pumped through a large heat exchanger to reduce temperatures. Raw water is circulated through the other side of the heat exchanger to dissipate heat absorbed by the coolant mixture.

Exhaust System

The engine and generator exhaust systems remove the gases produced by the running engines and vents them away from the yacht. The generator exhaust is expelled on the sides of the yacht. Engine exhaust is expelled below the waterline through the outdrives. Engine and generator cooling water are also removed along with the exhaust gases.



Lubrication System

The engines and generator use a pressurized continuous loop lubrication system that must be periodically serviced in accordance with the manufacturer's recommendations. The engines have electrical transducer units to provide oil pressure signals to the helm. Full oil pressure must be available for proper lubrication, so monitoring the engine information is important, especially when operating at cruising speeds and above.

Seaworthiness Inspection

The following checks are essential to safe boating and must be performed before starting the engines. Get into the habit of performing these checks in the same order each time so that it becomes routine.

- Check the weather report, wind and water conditions.
- Check that required safety equipment is onboard.
- Check that fire extinguishers are fully charged.
- Check that no fuel, oil or water is leaking or has leaked into the bilge compartment.
- Check all hoses and connections for leakage and damage.
- Check that all batteries are fully charged and have the proper level.
- Check electrical circuits (lights, pumps, horn, etc.) for proper operation.
- Check that steering system operates properly.
- Be sure the boat is not overloaded.
- Check that all maintenance has been performed.

Operation Checklist

While operating your yacht, frequently check that the control and steering systems continue to operate smoothly. Monitor your gauges for signs of abnormal behavior. Beware of any excessive vibration. Refer to *Section 3, Before Starting Checklist*.

WARNING

Avoid the risk of creating a hazardous situation. DO NOT operate the boat if any problem is found during this inspection.

Problems found during this inspection should be handled by your authorized Cobalt dealer.

Environmental Considerations

As a boater, you already appreciate nature's beauty and the peace of the great outdoors. It is a boater's responsibility to protect the natural environment by keeping waterways clean.

MARPOL Treaty

The USCG enforces the International Convention for the Prevention of Pollution from ships, commonly referred to as the MARPOL Treaty (MARine POLLution). This treaty prohibits the overboard dumping of all ship-generated plastics, chemicals, garbage and oil.

Fuel/Spillage

The spilling of fuel or oil into our waterways contaminates the environment and is dangerous to wildlife. Do not discharge or dispose of fuel or oil into the water; it is prohibited and you can be fined. These are two common, accidental types of discharge:

- Overfilling the fuel tanks
- Pumping contaminated bilge water

California Air Resource Board (CARB) Label

Your yacht may have an environmental star label affixed on the bow, port side of the yacht as part of the California Air Resource Board (CARB) SD/I rule. This label must stay affixed to the yacht if it is operated in California. The label identifies your yacht is equipped with a California Certified Engine. The label is positioned so it will be at the leading or trailing edge of the state registration numbers.



⚠ DANGER

Avoid fire or explosion. Fumes from rags can collect in bilge and be extremely hazardous. DO NOT store rags used to wipe up fuel or solvent spills in the boat. Dispose of rags properly ashore.

Emission Control Warranty Information



COB_0016_A

The engines in your Cobalt yacht meets the strict requirements set forth by the CARB. The engine has a special environmental tag and the yacht has this label

affixed to it. The tag and the label are required by the CARB. The label has 1, 2, 3 or 4 stars. The label **MUST** be affixed to the boat, if the yacht is operated in the state of California and/or bordering waters.

Proposition 65

⚠ WARNING

A wide variety of components used on this vessel contains or emits chemicals known to the state of California to cause cancer, birth defects and other reproductive harm.

EXAMPLES INCLUDE:

- Engine and generator exhaust
- Engine and generator fuel, and other liquids such as coolants and oil, especially used motor oil
- Cooking fuels
- Cleaners, paints and substances used for vessel repair
- Waste materials that result from wear of vessel components
- Lead from battery terminals and from other sources such as ballast or fishing sinkers

TO AVOID HARM:

- Keep away from engine, generator and cooking fuel exhaust fumes.
- Wash areas thoroughly with soap and water after handling the substances above.

Discharge/Disposal of Waste

Waste means all forms of garbage, plastics, recyclables, food, wood, detergents, sewage and even fish parts in certain waters - in short, nearly everything. We recommend you bring back everything you take out with you for proper disposal ashore. Use an approved pump-out facility at your marina. Many areas prohibit the discharge of sewage overboard or even an operable overboard waste discharge.

Excessive Noise

Noise means engine noise, radio noise or even voices. Many bodies of water have adopted noise limits. Music and loud conversation can carry a considerable distance on water, especially at night.



Wake/Wash

Be alert for NO WAKE zones. You may be responsible for any damage or injury caused by your wake/wash. Prior to entering a no wake zone, come off plane to the slowest steerable speed.

Exhaust Emissions

Increased exhaust (hydrocarbon) emissions pollute our water and air. Keep your engine tuned and yacht hull clean for peak performance. Consult your authorized Cobalt dealer and propulsion unit operator's manual for information.

Paints

If your yacht is kept in water where marine growth is a problem, the use of anti-fouling paint may reduce the growth rate. Be aware of environmental regulations that may govern your paint choice. Contact your local boating authorities for information.

Cleaning Agents

Household cleaners should be used sparingly and not discharged into waterways. Do not mix cleaners and be sure to use plenty of ventilation in enclosed areas. DO NOT use products which contain phosphates, chlorine, solvents, nonbiodegradable or petroleum based products. Citrus-based cleaners are excellent for marine cleaning purposes and are safe for you and the environment. Do not use citrus-based cleaners on stainless steel.

Fishery Resources

There is a tremendous drain on our fishery resources. Over-fishing and pollution have strained the fish population. Do your part by keeping only what you will eat and practice catch-and-release.

Foreign Species

If you transport your Cobalt yacht from lake to lake, you may unknowingly introduce a foreign aquatic species from one lake to the next. Thoroughly clean the boat below the waterline, remove all weeds and algae, and drain the bilge before launching the boat in a new body of water.

Components, Maintenance and Repairs

Only your authorized Cobalt dealer should make any alterations, modifications or repairs that could affect safety, design integrity or warranty coverage. Included with your owner's packet are your propulsion unit manuals. These manuals were prepared by the manufacturer and contain information concerning the operation and care of your engine and drive unit. Please read these manuals thoroughly and become acquainted with this information.

It is advisable to maintain a service log to record service checks, such as oil changes, so you can determine when it is time for servicing. A maintenance log is helpful when requesting warranty service using the extended warranty coverage. Be sure to collect receipts for work performed and make an entry in the Service Log in the back of this manual.

Emergency Considerations

Be prepared to deal with emergencies before they happen. Try to formulate a plan for each type in advance so that decisions can be made quickly and without hesitation. Precious moments lost can mean the difference between losing and saving a life.

Fire

You must be prepared and act quickly when dealing with a fire. It is not recommended to battle a fire for an extended period of time. Turn engines off and abandon the boat if the fire cannot be extinguished quickly. Swim at least 25 yards (23 meters) upwind from the boat and use the visual distress signals to get assistance. Onboard fires involving the fuel system usually result in either an explosion that completely destroys the boat, or the boat burning to the waterline and self-extinguishing. Deciding on abandoning the boat or staying to fight the fire is difficult and depends on many factors. Try to formulate a fire plan in advance to make that decision quickly and without hesitation.



The USCG and other law enforcement agency requirements for fire extinguishers are only the minimum needed. Your Cobalt yacht is equipped with at least one portable fire extinguisher and has a fixed fire extinguisher in the engine compartment. If you are in question of whether your boat is equipped with fixed fire extinguishers, contact your authorized Cobalt dealer. For the location of your fire extinguisher, refer to *Section 1, Layout*. Remember, install extra extinguishers where they might be needed and inspect extinguishers on a regular basis.

WARNING

Avoid injury or death. Gasoline will float on top of water and can burn. If the boat is abandoned, swim upwind, far enough to avoid fuel that may spread over the surface of the water.

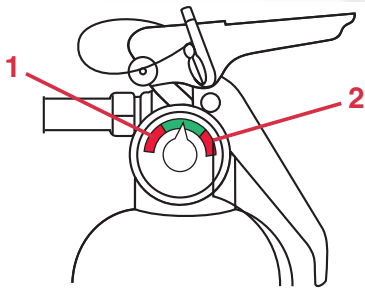

KC-0083C

- 1 – Recharge**
- 2 – Overcharge**

Be sure to:

- Use caution and do not smoke when refueling.
- Verify that fuel does not leak.
- Use only marine approved equipment on your yacht.

Flooding/Swamping

Improper loading, handling, water conditions, weather and anchoring are the most common causes of flooding. Insist on a safe, stable load. Do not operate the yacht exceeding your ability to maneuver it. Use extreme caution in hazardous weather and rough water conditions. Anchor from the bow when using one anchor.

Collisions/Leaks

If a collision occurs, immediately account for all passengers. Assess the hull for damage and activate the bilge pumps to reduce any water intake. Try to operate the yacht to keep the damaged area above water. If necessary, call or signal for assistance. If a leak is discovered, immediately determine the cause. A collision with an underwater object could cause the hull to develop a leak. A loose fitting or hose clamp on a piece of equipment could cause a leak. Try to repair the leak if possible. If a leak is threatening the safety of you and your passengers, call or signal for assistance.

Grounding

In the event you run aground, assess the situation before proceeding. Immediately stop any water from entering the yacht. Inspect the propulsion unit(s), steering and control systems, and the hull for damage. Maneuver the yacht to safe water only if the hull and all operating systems are in satisfactory operating condition. Otherwise, call or signal for assistance.

Storms

Take common sense precautions if you are forced to operate your yacht in stormy conditions.

- Wear personal flotation devices (PFDs).
- Stow gear below deck and batten down equipment on deck.
- Reduce speed and head for a safe place that you can easily reach.
- If you lose power, keep the yacht headed into the waves by using the anchor.

Water Rescue (Man Overboard)

Immediately react to a person that has fallen overboard. Keep the victim constantly in your sight. Safely return to the victim as soon as possible. Throw the person a PFD. Turn the engines off and help the person into the yacht.

Medical Emergency

Be prepared in the event of an emergency. Know how to use your first aid kit. Be aware of any special medical conditions of your passengers.



Drowning

React to a drowning victim the same as described in Water Rescue. Handle victims with care; they could be injured. If necessary, resuscitate the victim. Immediately signal for help and keep the victim warm.

Operation Failure

If you experience a propulsion, steering or control failure, immediately turn off the engines. Release the anchor to prevent drifting. Try to determine the failure and repair, if possible. Otherwise, call or signal for assistance.

Distress Signals

Federal law also requires boats 16 ft (4.8 m) and longer to carry day and night visual distress signals when operating on coastal waters, the Great Lakes, territorial seas or those waters directly connected to them, up to a point where the body of water is less than two miles wide. Carry several types of signaling devices to handle a variety of conditions. Have enough signals on board to last three days.



NOTICE: Some pyrotechnics are restricted from use on certain bodies of water, so check with local authorities.

Radio Communication

Radio communication is the most important avenue of receiving and sending information. Use a VHF/FM radio for short-range communication, and a single-sideband radio (SSB) for long-range. For all U.S. waters, the National Weather Service operates the NOAA Weather Radio (NWR). This service provides continuous weather information on the following VHF/FM frequencies:

- 162.400 MHz • 162.500 MHz
- 162.425 MHz • 162.525 MHz
- 162.450 MHz • 162.550 MHz
- 162.475 MHz

Coast Guard Marine Information Stations

- 2670.0 kHz • 8765.4 kHz
- 4428.7 kHz • 13113.2 kHz
- 6506.4 kHz

It is good practice to periodically monitor the weather.

Lifesaving Equipment

The following equipment may or may not be required by federal/local regulations.

Personal Flotation Devices

Federal law requires at least one Type I, II, III or V Personal Flotation Device (PFD) for each person on board or being towed, and at least one Type IV throwable PFD in the boat.

There are four types of PFDs to wear and one type used for throwing in emergency situations.

Type I Life Preserver: Most buoyant PFDs are effective on all waters, especially open, rough water.



TYPE I
LIFE PRESERVERS

KC-0041C

Type II Buoyant Vest: Good for calm water near shore on most inland waters where quick rescue is likely.



TYPE II
BUOYANT VESTS

KC-0051C



Type III Flotation Aid: Good for most inland water applications where quick rescue is likely. Comes in various styles and some are designed for water sport activities.



TYPE III
FLOTATION AIDS
KC-0042C

Type IV Throwable Device: Intended for heavy traffic inland waters where help is available. Designed to be thrown to a person in the water and should never be worn.

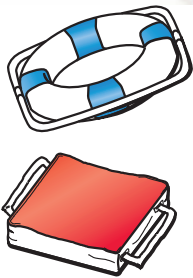

TYPE IV
THROWABLE DEVICES
KC-0071C

Type V Hybrid PFD: Inflatable design for special use activities and may be used instead of a Type I, II, or III PFD if used in accordance with the approval conditions on the label and if worn when the boat is underway. Some Type V PFDs provide increased protection against hypothermia.



TYPE V HYBRID PFD
MUST BE WORN
WHEN UNDERWAY

KC-0043C



NOTICE:

- **A Type V PFD must be worn to be counted toward the minimum carriage requirements.**
- **Special PFDs are available for skiing and other water sports. These PFDs are constructed with materials suitable for high impact falls.**

PFDs are intended to help save lives. The operator should set an example by wearing a PFD whenever boating. It is especially important that children and non-swimmers wear a PFD at all times.

Make certain all passengers know how to put on and properly adjust their PFDs. Also, selecting the proper type PFD for your kind of outing helps ensure your time on the water can be the safest possible. At the beginning of each season, check PFDs for damage and test for proper flotation. Refer to the PFD manufacturer's information.









Audible/Visual Distress Signals

A distress call is transmitted on VHF/FM radio channel 16 (156.800 MHz) or 2182 kHz (SSB). Know your audible signals:

- For emergency, the call sign is “Mayday.”
- For an urgent situation, the call sign is “Pan-Pan.”
- For navigational safety and weather warnings, the call sign is “Security.”

Repeat the call sign three times. Immediately react to a distress call. Assist, if possible, using an emergency frequency. Otherwise, continue to monitor the situation until help has arrived.

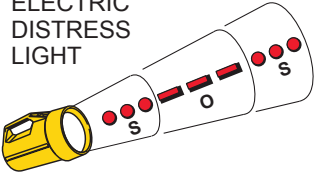
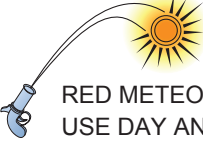
VISUAL DISTRESS SIGNALS

 <p>USE DAY ONLY</p>	<p>RED DISTRESS FLARE (HAND)</p>  <p>USE DAY AND NIGHT</p>
 <p>ARMS SIGNALS (USE BRIGHT CLOTH)</p> <p>USE DAY ONLY</p>	<p>USE DAY ONLY</p>  <p>SIGNAL (HAND)</p>
<p>ELECTRIC DISTRESS LIGHT</p>  <p>USE NIGHT ONLY</p>	<p>RED METEOR FLARE</p> <p>USE DAY AND NIGHT</p> 
<p>DYE MARKER</p> <p>USE DAY ONLY</p> 	

COB_0031_A

If you are required to carry distress signals, you must have three USCG-approved pyrotechnic devices. Be sure they are in serviceable condition, not exceeding the expiration date and stored in a cool, dry location in a waterproof container.

Sea Anchors

You should have a separate sea anchor onboard to slow drifting. In heavy seas, a sea anchor is set from the bow to control the behavior of the yacht. The sea anchor holds the bow to the sea and a slow drift.

Life Raft

If operating offshore, you should consider carrying an inflatable life raft, if not originally equipped. A USCG approved life raft meets a number of stringent specifications. The life raft must be large enough to hold all the occupants of the yacht and have its own equipment pack including a paddle.

A life raft can be stored in the aft storage area or in any other accommodating place on your yacht.

SAFETY

The popularity of boating and other water sports has undergone an immense growth over the past few years. Because of this, safety is an important issue for everyone who shares in the use of our waterways. Be smart when boating and using your equipment.

In emergency situations, it may be necessary to resort to measures which are not commonly practiced. Always assess the dangers of being in harm's way versus the protection of equipment. Keep a sound mind during an emergency and always think safety.

- Know the conditions of your boat and the environment.
- Have a float plan and inform others when you will return.
- Secure or store loose items before getting underway.
- Avoid sudden maneuvers at high speed and reduce speed in waves.

WARNING

Avoid fire, explosion, injury or property damage from improperly handled pyrotechnic signaling devices. Follow the manufacturer's directions.



Signal Words/Definitions

Throughout this manual specific precautions and symbols identify safety related information.

The Safety Alert Symbol means ATTENTION! BECOME ALERT! YOUR SAFETY IS INVOLVED!

 **DANGER**

Indicates a hazardous situation which, if not avoided, will result in death or serious injury.

 **WARNING**

Indicates a hazardous situation which, if not avoided, could result in death or serious injury.

CAUTION

Indicates a hazardous situation which, if not avoided, may result in minor or moderate injury.



NOTICE: Indicates a property damage message.

The precautions listed in this manual and on your Cobalt yacht are not all-inclusive. If a procedure, method, tool or part is not specifically recommended, you must satisfy yourself that it is safe for you and others, and that the yacht will not be damaged or made unsafe as a result of your decision. REMEMBER - USE COMMON SENSE WHEN OPERATING YOUR YACHT!

General Safety

Before each outing you should check all safety equipment, such as fire extinguishers, PFDs, flares, distress flags, flashlights and engine stop switches. They should be operable, in good condition, readily visible and easily accessed.

Check local weather reports before casting off; do not leave the dock area when strong winds and electrical storms are in the area or predicted to be in the area.

Tell someone your travel plans and leave them a float plan. A float plan makes the job of search and rescue much easier for authorities. A float plan template can be found in the back of this manual.

Seating

Keep your passengers seated in seats. The bow, gunwale, transom platform and seat backs of the yacht are not intended for use as seats while underway.

Handholds

 **WARNING**

Avoid injury or death.

- Passengers should use handholds whenever the boat is underway.
- **DO NOT** allow passengers to sit on or in the stern sun lounges when the boat is underway.
- Read and understand this manual and the propulsion unit manual, and be sure that you understand all controls and operating instructions before attempting to operate the boat.
- Be in control of your boat. **DO NOT** operate your boat under the influence of alcohol or other drugs.

Handholds are provided for your passengers' safety. Be sure your passengers use the handholds whenever the yacht is underway. Failure to use handholds could result in a person overboard situation or personal injury.

Capacity

Know the weight capacity of your yacht. Do not overload your yacht. Overloading of passengers, personal equipment and supplies could result in an accident, especially in rough waters.



Loading

Be sure that passengers, personal equipment and supplies are in their proper location before operating the yacht. This does not necessarily mean you can carry a passenger for every seat. Keep personal equipment and supplies to an “as needed” basis. Maintain a balanced load (front to back and side to side) at all times.

Operating Conditions

Every waterway poses hazards that you should avoid, such as shallow water, tree stumps and sand bars. Ask local boaters for information and consult a marine chart when boating on unfamiliar waters. As the operator of the yacht, you should try to avoid all hazards, known and unknown. The following information does not contain all possible water hazards. Operating in shallow water presents a number of hazards. Mud, sand, weeds and debris can foul a propulsion unit propeller or its cooling water. If a propulsion unit strikes an underwater object, check the propulsion unit and yacht for damage. If a propulsion unit vibrates after striking an object, it may indicate a damaged propeller.

Sand bars in narrow inlets are constantly shifting, making it difficult to mark them with buoys. Tides in coastal areas affect water levels, producing sand bars. Sometimes sand bars are indicated by waves as they form into breakers when passing over the sand bar. Refer to **Grounding**, in this section, if you run aground on a sand bar. The water level around a dam spillway is a hazardous area. It is subject to rapid changes caused by currents and turbulence. Keep clear of the spillway areas below dams.

Weather/Seas







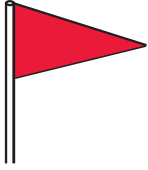

Getting caught in severe weather is hazardous. It is recommended to check the weather, sea and wind conditions not only before you boat, but also periodically while you are boating. Refer to **Radio Communications**, in this section, for weather channel information. A change in wave height, wind direction and speed indicates deteriorating weather. Take common sense precautions if you are forced to operate your yacht in stormy conditions:

- Wear PFDs.
- Stow gear below deck and batten down equipment on deck.
- Reduce speed and head for a safe place that you can easily reach.

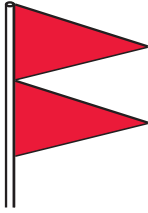
If you lose power, keep the yacht headed into the waves by using the anchor.



Learn the storm signals.

DAYTIME WARNING	DESCRIPTION	NIGHTTIME WARNING
	Small Craft Advisory - Winds greater than 18 knots, sustained for two hours or more or hazardous wave conditions. Following a storm, hazardous wave conditions can persist long after the high winds have subsided.	
	Gale Warning - Sustained winds (2 or more hours), of 34-47 knots.	
	Storm Warning - Sustained winds of 48 knots or greater.	
	Hurricane Warning - Forecast winds of 64 knots and above. Displayed only in connection with a hurricane.	

COB_0032_A

It is best to avoid operating your yacht in foggy weather. When fog sets in, use your GPS and radar unit, if equipped, to take bearings and log courses and speeds. You are required to emit a five-second blast from your horn or whistle once every minute. Additionally, have passengers wear PFDs and observe for oncoming vessels.

Skill/Experience

WARNING

Avoid injury or death from drowning. Wear your Personal Flotation Device and remain seated when operating the boat.

Practice your boat operating skills often in calm water. Avoid windy conditions and rough water. Be sure to maintain good visibility at all times. Do not practice close to any obstructions such as piers, bridges, swim areas or moored boats.

Proceed slowly and give yourself plenty of time to react. Remember, your yacht is not an automobile. It requires additional time to maneuver and stop.

Visibility

WARNING

Avoid injury or death. Maintain clear visibility at all times. If necessary, arrange passengers and equipment. Designate a passenger to assist when visibility is limited due to operating conditions.

Visibility is not only sight, but also hearing. It is very important the operator maintains good visibility at all times. Arrange passengers and equipment to ensure you have unobstructed vision at all times. Check for other boats or any obstacles before turning the yacht.

Drugs/Alcohol

WARNING

Avoid injury or death from impaired operation. Federal and state law prohibit operating a boat under the influence of alcohol and other drugs. These regulations are actively enforced.



Boating, alcohol and the use of other drugs just do not mix. Mixing boating, alcohol and other drugs results in many marine accidents and deaths. These substances reduce your reaction time and affect your better judgment. Combined with the sun, wind, waves, and noise of other watercraft, the effects of drugs are increased and will significantly reduce your reaction time. Do not operate your boat under the influence of alcohol or other drugs. As the owner/operator, you are responsible for the alcohol/drug use and onboard behavior of your passengers.



KC-0153C

If the operator's blood alcohol content is above the state's legal limit, violators are subject to a civil or criminal penalty, imprisonment or both. Operating a boat under the influence can also result in a loss of automobile driving privileges.

Passengers

Whenever you are going for an outing, make sure that at least one passenger is familiar with the operation and safety aspects of the yacht in case of emergency. Show all passengers the location of emergency equipment and explain how to use it. Do not allow passengers to drag their feet or hands in the water, or sit on the bow, deck, gunwale or transom platform while engines are running.

Ventilation

Your Cobalt yacht is equipped with carbon monoxide (CO) detectors in areas designed for occupancy, except the bilge area and cockpit.

⚠ DANGER

Avoid the possibility of injury or death from exposure to carbon monoxide (CO). All gasoline and diesel engines and fuel burning appliances such as heaters, stoves and generators produce carbon monoxide (CO). CO is a colorless, odorless and dangerous gas. Direct and prolonged exposure to CO will cause brain damage or death. Signs of exposure to CO include nausea, dizziness, drowsiness, ears ringing, headaches, unconsciousness and cherry red skin color. Avoid exposing your passengers or yourself to carbon monoxide. Test the carbon monoxide detector operation before each trip, at least once a week and after the boat has been in storage. DO NOT tamper with the operation of the carbon monoxide detector. It is installed for your safety.

A carbon monoxide (CO) detector will only detect the presence of carbon monoxide gas at its sensor and will not detect other vapors such as gasoline. Carbon monoxide may be present in other areas.

Carbon monoxide poisoning should not be confused with seasickness, intoxication or heat stress. If someone complains of irritated eyes, headache, nausea, weakness or dizziness, or you suspect carbon monoxide poisoning, immediately move the person to fresh air, investigate the cause and take corrective action. Seek medical attention if necessary.



To reduce CO accumulation:

- Ventilate the boat interior by opening the deck hatches, windows and cabin door to provide adequate ventilation.
- Do not operate the engines or generator with the canvas installed.

- Avoid idling or using the generator while at idle for extended periods.
- Regularly inspect the engine and generator exhaust system for proper operation.

For additional information, refer to the carbon monoxide detector operator's manual supplied with your boat.

Blockage of boat exhausts by obstruction.

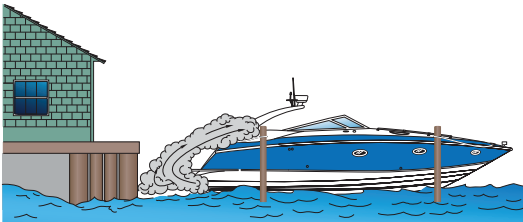

Operating with high bow angle.

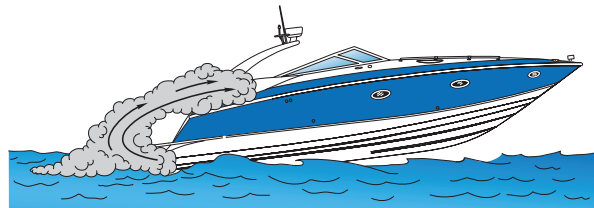

Exhausts traveling along obstruction.

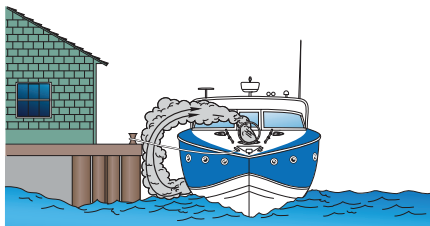

Exhausts from other vessels in confined areas.

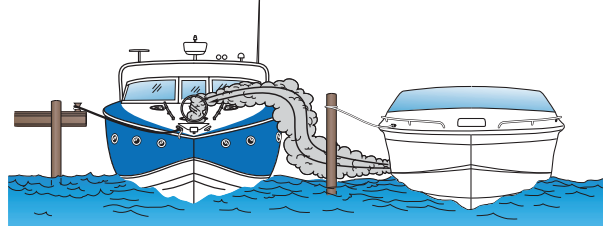

Operating at slow speed or while dead in the water.

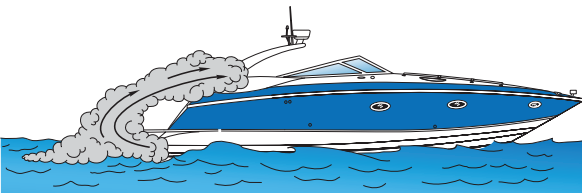

Operating with canvas tops and side curtains in place without ventilation.



COB093



Qualified Boat Operators

This manual is not intended to provide complete training on all aspects of boat operation. We strongly recommend that all operators of this yacht seek additional training on boat handling and safety. Have all operators become familiar with the handling characteristics, and proper steering and control system usage before attempting high-speed operation.

Some states require youths 16 years of age and younger to complete a boating safety course before operating any watercraft. Many others require operators under the age of 18 to be licensed in small boat operation.

Minors must be supervised by an adult whenever operating a boat. Many states have laws regarding the minimum age and licensing requirements of minors. Be sure to contact the state boating authorities for information.

Safety While Boating

Your Cobalt yacht is affixed with various safety labels at the time of manufacture. These labels appear at specific locations on the craft where safety is of particular concern. Refer to *Section 1, Warning Labels*.

Safety labels must remain legible. If you suspect a label is missing or becomes damaged, contact your authorized Cobalt dealer for immediate replacement.

Federal, State and Local Regulations

The USCG is the authority of the waterways; it is there to help the boating public. State boating regulations are enforced by local authorities. You are subject to marine traffic laws and “Rules of the Road” for both federal and state waterways; you must stop if signaled to do so by enforcement officers, and permit to be boarded as asked.

Discharge of Oil

The discharge of fuel, oil and other chemicals into the water is prohibited. Be sure to clean up all fuel and oil spillage in the bilge using rags and sponges. Properly store and dispose of them when you get to shore. Do not allow any fuel or oil spills to be pumped out into the water. If fuel or oil leaks continue to be a problem, immediately have the problem repaired.

When refueling, do not “top-off” the fuel tanks. Allow for expansion, which will reduce fuel spills from the fuel tank vents.

Solid Waste Disposal



NOTICE: It is illegal to dispose of any plastic trash into waters of the U.S.

The disposal of solid waste and plastics into the water is prohibited. Bag all refuse and properly dispose of it when you get ashore.

Marine Sanitation



NOTICE: Direct disposal of sanitation waste into some waters could result in fines. Be sure to check local regulations.



NOTICE: Avoid damage to the waste disposal system and the environment. Do not place facial tissues, paper towels or sanitary napkins in the head.

Have your authorized Cobalt dealer properly service the waste disposal system when needed.

Excessive Noise

Noise limits are regulated in many areas. Be sure to follow regulations and be courteous.



Wake/Wash

⚠ WARNING

Avoid injury, death or damage to property. Observe “No Wake” markers. Use caution when operating around smaller crafts, in channels and marinas, and in congested areas. You are responsible for injury and damage caused by your wake.

Reporting Accidents

The USCG requires the owner or operator of a boat involved in an accident to report the incident to the proper marine law enforcement agency for the state in which the accident occurred.

Immediate notification to the nearest state boating authority is required if a person dies or disappears as a result of a recreational boating accident. If a person dies or sustains injuries requiring more than first aid, a formal report must be filed within 48 hours of the accident. A formal report must be filed within 10 days for accidents exceeding \$500 in property damage or complete loss of boat.

Rendering Assistance

If you see a distress signal or suspect a boat is in trouble, you must assume it is a real emergency and render assistance immediately. By law, the operator in charge of the craft is obligated to provide assistance to any individual in danger if such assistance can be provided safely. Failure to render assistance can result in a fine and/or imprisonment.

The 1971 Boating Safety Act grants protection to a “Good Samaritan” boater providing good faith assistance, and absolves a boater from any civil liability arising from such assistance.

Water Sports Safety

Larger boats produce a larger wake which may be too big for skiers. Only boats equipped with a ski-tow eye should be used to pull water skiers. If you use your Cobalt yacht for water sports, you should be familiar with water sport safety and hand signals.



NOTICE: It is unlawful to participate in water sports while under the influence of alcohol or other drugs.

When participating in water sports, be safe and courteous and follow these guidelines:

- Be considerate to fishermen and others you share the water with.
- Do not perform water sports in congested areas.
- Stay away from navigation markers.
- Stay away from other boats and water sport participants.
- Return immediately to a fallen water sport participant and turn off engines.
- Regularly inspect water sport equipment to ensure it is safe.
- Do not use any fuel burning appliances with a transom exhaust port when swimming from the stern swim platform.

⚠ DANGER

Avoid injury or death. DO NOT practice unsafe water sports.



- Water sport participants must wear a USCG approved flotation device. A Type III water ski vest is an approved and practical PFD.
- Keep at least 100 ft (30 m) away from all other objects.
- Have an experienced driver and aft-facing observer in the boat when water sporting.
- Do not water sport in shallow water or at night.
- Do not jump from a moving boat.
- Keep a downed water sporter in sight.
- Turn the engine(s) off before you get close to someone in the water.
- Do not use the boarding ladder with engine(s) running.

Skiers and/or passengers are obligated to be aware of the same safety rules as operators. If you are new to water sports, seek certified training before starting. You will find it especially helpful to join a ski club, World Wakeboard Association and/or the U.S.A. Water Ski when it is possible. Always remember the majority of water sport injuries result from impact with other objects.

Always look where you are going and be aware of your surroundings.

Platform Dragging (“Teak Surfing”)

READ, KNOW and UNDERSTAND the information on warning labels and adhere to the boat operation practices described on them. The USCG issued a SAFETY ALERT on August 28, 2001, which covers some issues regarding improper use of the boarding ladder/swim platform. The SAFETY ALERT and portions of the information follow:

Tragic deaths occur from the negligence of unsafe boating and dangerous activities. Experts say, “many of these deaths may have been caused by an invisible hazard, carbon monoxide poisoning.” Taking the risk of swimming under a boarding platform when the engine is running, skiing within 20 ft (6.1 m), or “teak surfing” or “dragging” behind a moving boat, can be fatal. Dangerous activities which can result in serious injury or death are not considered water sports. Cobalt Boats does not promote unsafe boating risks or jeopardizing any boater’s safety. “Teak Surfing” or “Platform Dragging” may be illegal in your state, or the states you operate in.

⚠ WARNING

Avoid injury or death. DO NOT use the swim platform for any other purpose than boarding the boat or preparation of entering the water, and do not use the swim platform when engines are running.

Carbon monoxide poisoning should not be confused with seasickness, intoxication or heat stress. If someone complains of irritated eyes, headache, nausea, weakness or dizziness, or you suspect carbon monoxide poisoning, immediately move the person to fresh air, investigate the cause and take corrective action. Seek medical attention if necessary.



SAFETY ALERT FROM AUGUST 28, 2001:

The United States Coast Guard advised boaters not to “Teak/Drag Surf.” Recent boating fatalities revealed carbon monoxide (CO) emitted from a vessel’s exhaust resulted in CO poisoning and death. Do not allow persons in the vicinity of the Swim Platform (in the water or in the boat) with the engine(s) or generator operating, while at rest or underway at slow speed. “Teak/Drag Surfing” places the individual in a position directly exposed to the CO in the exhaust of the engine. This can result in a loss of coherent responses and even death. In addition, “Teak/Drag Surfing” dangerously exposes the individual to a possible propeller injury. Since “Teak/Drag Surfing” is done without a life jacket (PFD), it significantly increases the probability of drowning. The Coast Guard stresses, “Teak/Drag Surfing” is a very dangerous activity and advises boaters not to participate in it.

The Coast Guard also stated that carbon monoxide is one of the most dangerous gases. It strikes before you know you are exposed and it impairs in a way that can, and too often does, lead to death. This is why the Coast Guard feels it is critical that carbon monoxide is avoided in every circumstance.

Navigation

“Rules of the Road”/Sound Signals

The General Prudential Rule regarding right-of-way is that if a collision appears unavoidable, neither boat has right-of-way. As prescribed in the “Rules of the Road,” both boats must act to avoid collision.

The information in this section outlines only the most basic of the nautical “Rules of the Road.” For more information, contact your local USCG Auxiliary.

WARNING

Avoid injury, death or collisions. Like traffic laws for automobiles, the operator is legally required to follow the rules.

In general, boats with less maneuverability have right-of-way over more agile craft. You must stay clear of the vessel with right-of-way and pass to the stern of that vessel.

Whistle/Horn Signals

Signaling other boats with a whistle or horn is similar to using turn signals on an automobile. It is not necessary to sound a signal every time a boat is nearby. In general, boat operators should signal their intention, as to avoid potentially confusing or hazardous situations.

It is customary for the privileged boat to signal first, and the burdened boat to return the same signal to acknowledge she understands and will comply. Use the danger signal (five or more short and rapid blasts) if intent is not clear.

Use the following signal blast early enough to be noticed and understood by other boaters:

- One long blast: Warning signal (coming out of slip or passing astern)
- One short blast: Pass on my port side
- Two short blasts: Pass on my starboard side
- Three short blasts: Engines in reverse
- Five or more short and rapid blasts: Danger signal!

Privileged Boats

Privileged boats have right-of-way and can hold course and speed. Sailboats and boats paddled or rowed have the right-of-way over motor boats. Sailboats under power are considered motorboats. Small pleasure craft must yield to large commercial boats in narrow channels.

Burdened Boats

The burdened boat is the boat that must make the necessary adjustment to course and speed to keep out of the way of the privileged boat.



Crossing Situation

In crossing situations, the boat to the right from the 12 o'clock to the 4 o'clock position has the right-of-way. It must hold course and speed. The burdened boat keeps clear and passes behind the privileged boat. Boats going up and down a river have the privilege over boats crossing the river.

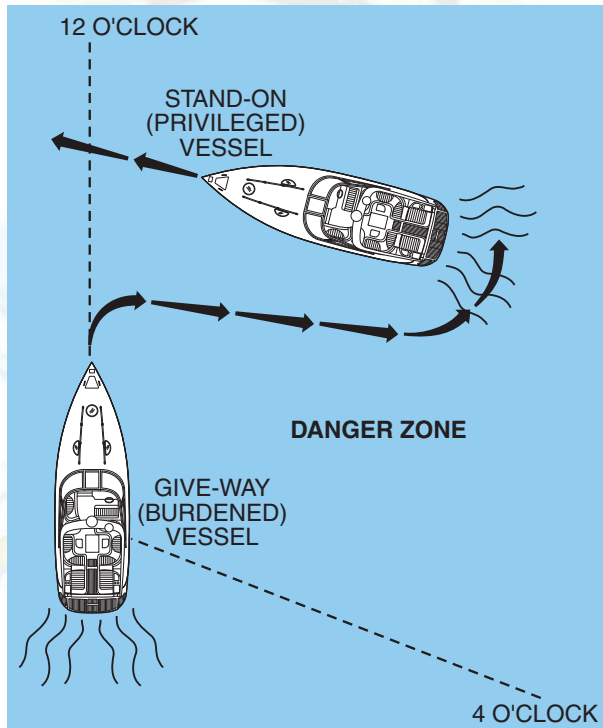

COB017C

Meeting Head-On

Neither boat has the right-of-way in this situation. Both boats should decrease speed, should turn to the right and pass port-to-port. However, if both boats are on the left side of the channel, each vessel should sound two short blasts and pass starboard-to-starboard.

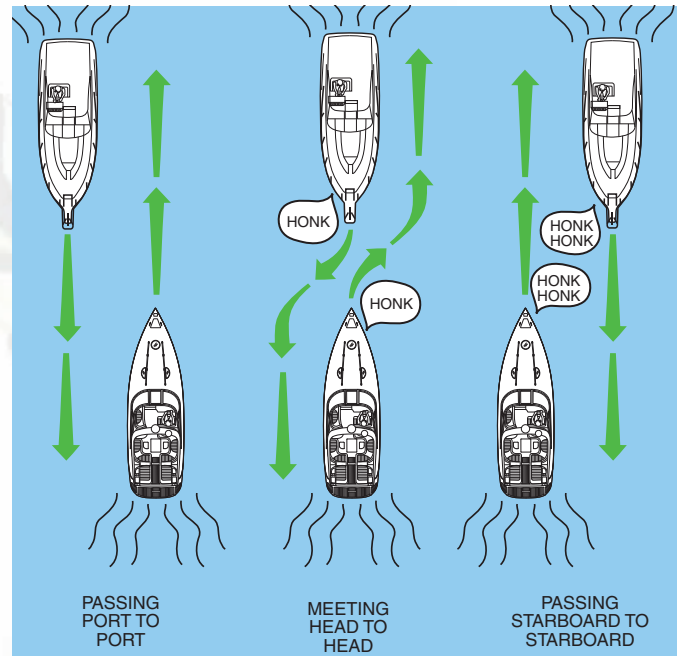

COB018C



Overtaking

The boat that is overtaking one ahead of it is the burdened boat and must make any adjustments necessary to keep out of the way of the privileged boat. The privileged boat should hold its course and speed.

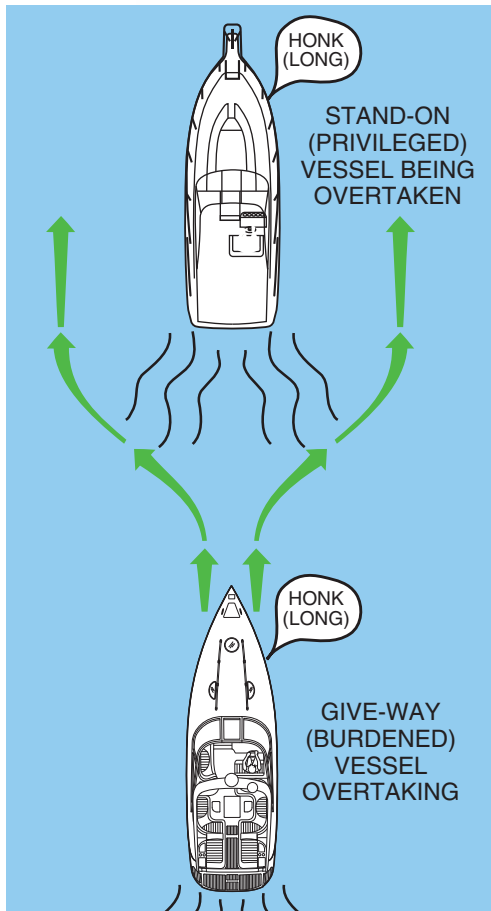

Special Situations

Boats operating between sunset and sunrise (hours vary by state) must use navigational lights, nighttime operation, especially during bad weather or fog can be dangerous. All “Rules of the Road” apply at night; it is best to slow down and stay clear of all boats, regardless of who has right-of-way.

Protect your night vision by avoiding bright lights and have a passenger, if possible, help keep watch for other boats, water hazards and aids to navigation.

The size, speed and direction of the other vessels are determined at night from their running lights. A green light indicates the starboard side of the boat, and a red light indicates the port side. Generally, if you see a green light, you have the right-of-way; if you see a red light, give-way to that vessel.

Aids to Navigation

Learn to recognize the different buoys and day markers; they are the signposts of the waterways. The United States Aids to Navigation System (USATONS) is the primary marking system used on inland water, coastal waters and rivers. This system is maintained by the U.S. Coast Guard (USCG).

Types of Buoys

There are several types and shapes of buoys. Buoys may be unlighted, lighted, with sound or may have both an audible and a visual signal. Lights, bells and horns are used on buoys for night or poor visibility conditions. Different shapes of buoys are shown below.



UNLIGHTED BELL BUOY



SPAR BUOY



CAN BUOY



LIGHTED BUOY



NUN BUOY



SPHERICAL SAFE WATER MARKER

KC-1908

Buoys with unique light-flashing characteristics are identified on nautical charts with the specific flashing pattern.



Mooring Buoys

The only buoys you are permitted to moor to are mooring buoys. Mooring buoys are white with a blue horizontal stripe. Mooring to a navigation buoy, regulatory markers or lateral markers is illegal.



KC-1901

Regulatory Markers

Regulatory markers indicate dangerous or restricted controlled areas. These markers are used to indicate speed zones, areas set aside for particular use, general information and directions.

Regulatory markers are white with orange geometric shapes and also have orange bands near the top and at the waterline of the buoy. You must obey regulatory markers (see below).

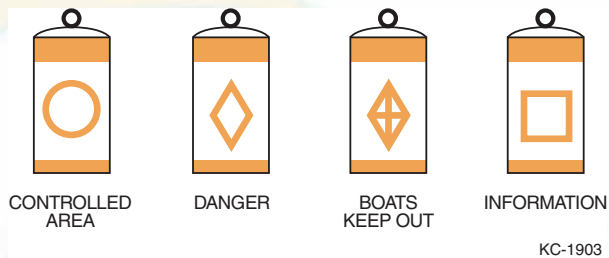



Lateral Markers





Lateral markers are oriented from the perspective of being entered from seaward (the boater is going toward the port). This means that red buoys are passed on the starboard (right) side of the vessel when proceeding from open water into port, and green buoys to the port (left) side.

The right side (starboard) of the channel is marked with RED, even-numbered buoys. The left side (port) of the channel is marked with GREEN, odd-numbered buoys.

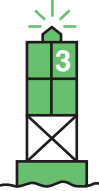
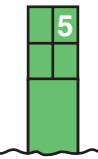

Day markers are colored and numbered the same as buoys. RED, triangular day markers with even numbers mark the starboard side of the channel.

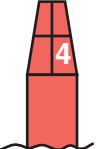
GREEN, square day markers with odd numbers mark the port side of the channel.

Fairways and mid-channels may be marked with safe water marks or buoys. These marks indicate safe water all around. Safe water marks are red and white striped and are round or have a red spherical topmark.

Lateral Aids Marking the Sides of Channels as Seen When Entering From Seaward	<div style="border: 1px solid black; padding: 5px; margin-bottom: 10px;"> ■ GREEN LIGHT ONLY Flashing (2) Quick Flashing Flashing Iso Occulting </div> <div style="display: flex; justify-content: space-around; align-items: center;"> <div style="text-align: center;"> <p>Port Side Odd Numbers</p>  Lighted Buoy </div> <div style="text-align: center;">  Can Buoy </div> <div style="text-align: center;">  Daymark </div> </div>
	<div style="border: 1px solid black; padding: 5px; margin-bottom: 10px;"> ■ RED LIGHT ONLY Flashing (2) Quick Flashing Flashing Iso Occulting </div> <div style="display: flex; justify-content: space-around; align-items: center;"> <div style="text-align: center;"> <p>Starboard Side Even Numbers</p>  Lighted Buoy </div> <div style="text-align: center;">  Nun Buoy </div> <div style="text-align: center;">  Daymark </div> </div>

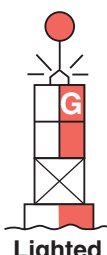
KC-1909

Safe Water Aids Marking Mid-Channels and Fairways (No Numbers—May be Lettered)	<div style="border: 1px solid black; padding: 5px; margin-bottom: 10px;"> □ WHITE LIGHT ONLY MORSE CODE Mo (A) </div> <div style="display: flex; justify-content: space-around; align-items: center;"> <div style="text-align: center;">  Lighted </div> <div style="text-align: center;">  Spherical Buoy </div> <div style="text-align: center;">  Daymark </div> </div>
---	---

KC-1910

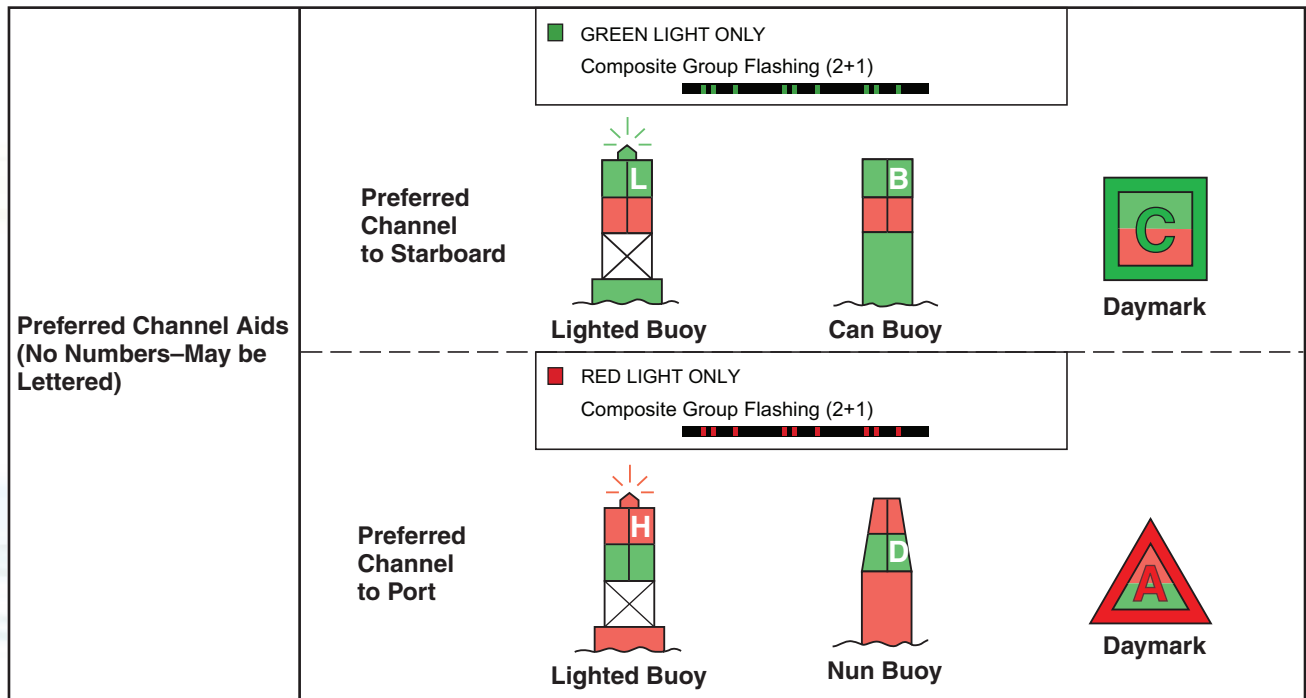

KC-1911

Obstructions, channel junctions, etc. are marked with RED and GREEN horizontally striped buoys.

A RED band at the top means the preferred channel is to the left of the buoy; a GREEN top band means the preferred channel is to the right of the buoy.



Isolated Danger Markers

Isolated danger markers indicate an isolated danger which may be passed on all sides. These markers are colored black with one or more broad horizontal red bands and are equipped with a topmark of two black spheres, one above the other.

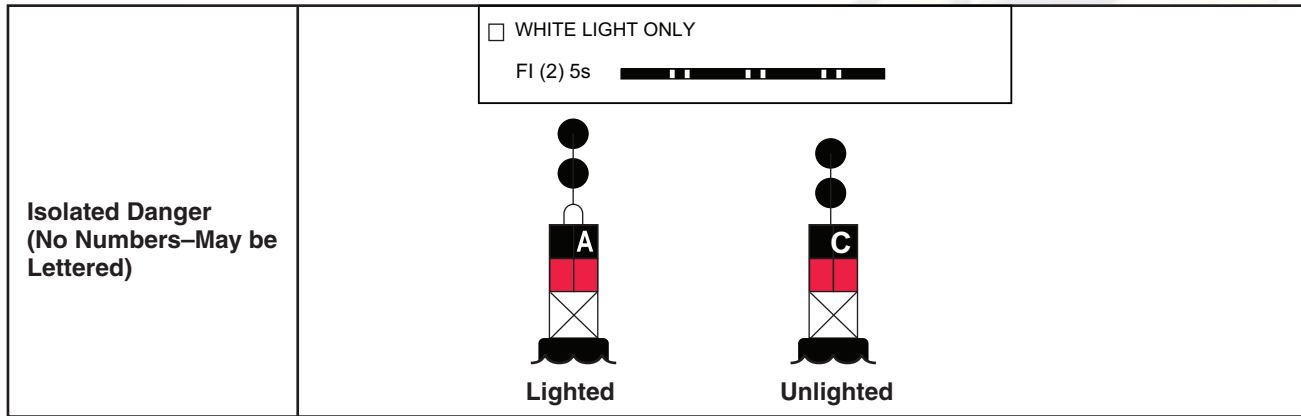

KC-1912

On inland waters, a buoy with alternating vertical black and white stripes may be used to indicate that an obstruction or other danger exists between the buoy and the nearest shore. DO NOT pass between the buoy and the shore.

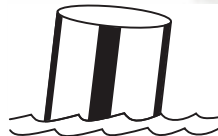

BLACK-STRIPED
WHITE BUOY

KC-1902

Light Structures

Maneuvering a boat at night can be dangerous and confusing. To aid boaters with navigation and warn of hazards, the USCG and the state and local authorities maintain a variety of light structures. Some light structures may be equipped with radio beacons, radar reflectors and/or signals.

Minor Lights

Minor lights are colored according to the buoyage marking system in use. They are similar to lighted buoys, except they are usually higher and on more stable platforms to increase visibility. Most minor lights are part of a series to mark a channel, river or harbor.



Range Lights

Range lights are usually visible in one direction and help a boat operator navigate in a generally safe direction. Steering a course to keep range lights arranged in a line (one on top of the other) will help guide a boat through a channel.

RANGE LIGHTS

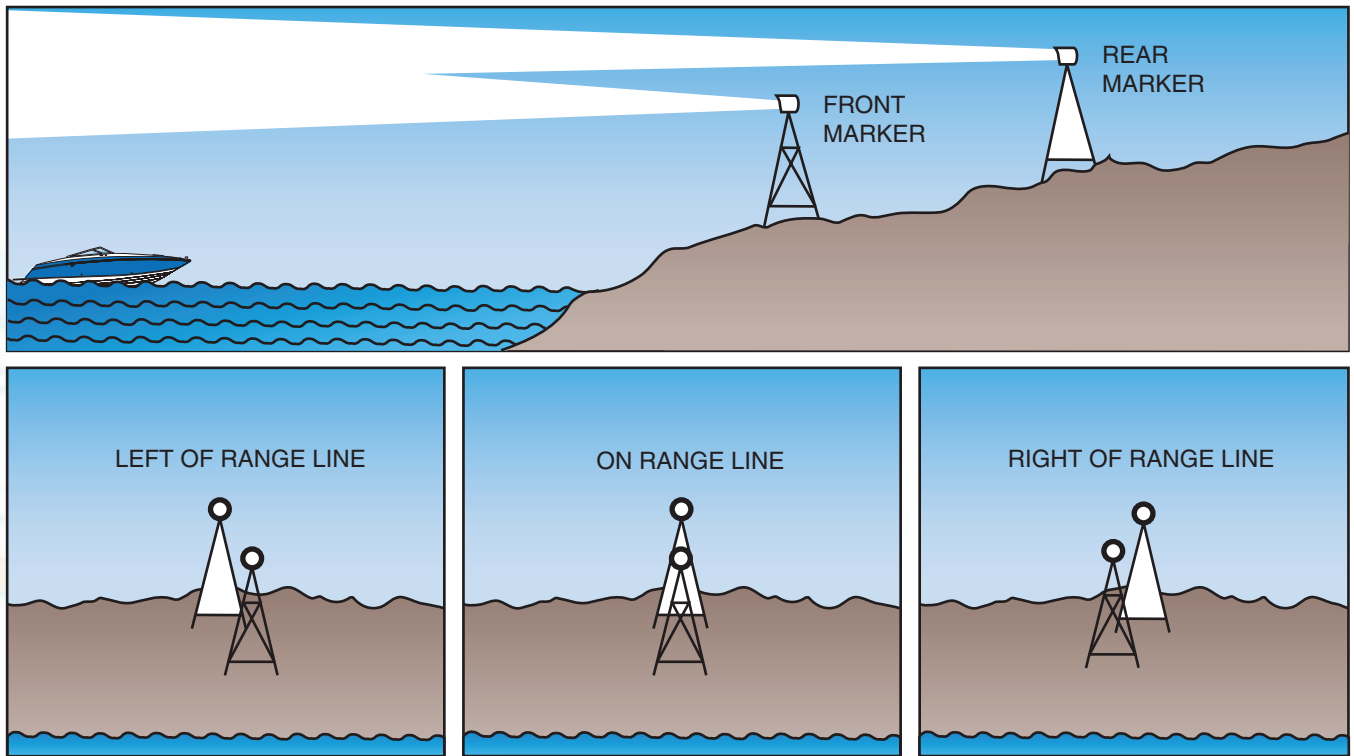

COB_0038_A

Lighthouses

Lighthouses can be found at harbor entrances, prominent headlands, isolated danger areas and along the coast. These striped or patterned structures have unique flashing characteristics to help identify them.

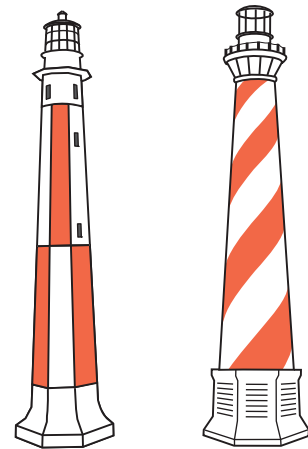

KC-0443C



Warning Markers

DIVERS FLAG



USED BY RECREATIONAL DIVERS - INDICATES DIVER'S POSITION

ALPHA FLAG

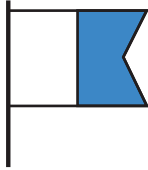

WORLDWIDE VESSELS ENGAGED IN DIVING OPERATIONS - DOES NOT INDICATE DIVER'S POSITION

DISTRESS FLAG



INDICATES FELLOW BOATER IS IN NEED OF ASSISTANCE

COB_0039_A

It is a good idea to ask local authorities if there are hazardous areas in the waters in which you plan to boat, and how they are marked. Boaters must also recognize the flag designs which indicate that skin divers are present and keep well clear of the area.



KC-0250C

Watch for swimmers. Swimming areas may not be marked. Steer clear from the area and remain alert.



OPERATING INFORMATION

This section is not intended to provide complete training on all aspects of boat operation.

We strongly recommend that all operators of this Cobalt yacht seek additional training on boat handling and safety. Have all operators become familiar with the handling characteristics and proper steering and control system usage before attempting operation.

The features described in this section are standard or optional, depending on your model. Refer to **Standard Equipment** and **Optional Equipment**, in this section, for a list of features for this model.

PRECAUTIONS

Before You Start

Become familiar with the location and operation of all equipment. Have emergency plans in place. Be sure to perform a safety check before operating your boat.

Fire/Explosion

Most fires are the result of fuel and oil accumulating in the bilge from careless fueling practices. Use the fire extinguisher at the base of the flames using a sweeping motion. Prudent and accurate use of the available chemicals should contain all but the worst fires. Verify that the fire has been extinguished. If so, check damage and get assistance immediately. If not, get out and swim at least 25 yards (23 meters) upwind from the boat and use the visual distress signals to get assistance. Refer to *Section 2, Safety*, for additional information.

FIRST TIME OPERATION

WARNING

Avoid injury or death. Improper operation can be extremely hazardous. Read and understand this manual, the propulsion unit operator's manual and any other accessory or components of your boat. Be sure that you understand all controls and operating instructions before attempting to operate the boat.

Your safety, the safety of your passengers, and the safety of other boaters are among your responsibilities as operator of this boat.

Your boat must be in compliance with USCG safety equipment regulations.

You should know how to react correctly to adverse weather conditions, have good navigation skills and follow the "rules of the road" as defined by the USCG and state, county and local regulations.

We cannot stress enough the importance of reading your propulsion unit operator's manual and following the manufacturer's instructions for breaking in your engines.

Before each outing you should check all safety equipment, such as fire extinguishers, PFDs, flares, distress flags and flashlights. They should be operable, in good condition, readily visible and easily accessed.



FUEL (DIESEL ONLY)

Fueling

Take care not to spill fuel. If fuel is accidentally spilled, wipe up all traces of it with dry rags and immediately dispose of the rags properly ashore. Spilled fuel may yellow the gelcoat finish and damage gunwale trim.

DANGER

Avoid injury, fire or explosion. Take all precautions every time you fuel your boat, regardless of the fuel type. Certain fuel is extremely flammable and highly explosive under certain conditions. Fumes from rags can collect in bilge and be extremely hazardous. Operate the blowers for at least four minutes. Do not store rags used to wipe up fuel or solvent spills in the boat. Dispose of rags properly ashore.



NOTICE: Prevent unwarranted engine damage. Use the recommended fuel type. Refer to your propulsion unit operator's manual.

DANGER

Avoid injury, fire or explosion. Fuels are extremely flammable and highly explosive under certain conditions.

- **Stop engines, generators and any fuel-operated machinery.**
- **Do not smoke or allow open flames or sparks within 50 ft (15 m) of the fueling area.**
- **Avoid damaging fuel lines and connectors, and the contact of fuel on hot engine parts.**
- **Do not store fuel in any containers or compartments which are not designated for fuel storage.**
- **Clean up any spilled fuel immediately and dispose of rags properly ashore.**
- **Know the dangers associated with fuels.**



NOTICE:

- **Each time you refuel, inspect all fuel lines, hoses and connections for leaks and deterioration.**
- **The Federal Water Pollution Control Act prohibits the discharge of oil or oily waste into the water. Violators can be fined \$5,000.00. We urge you to protect our fragile environment by avoiding any type of discharge, trash or litter into our waterways.**



When Fueling:

1. Know your fuel tank capacity. Be sure to have enough fuel to reach your destination. If departing for an extended cruise, know the availability of fuel along your route. Practice the One Third Rule: one third to reach the destination, one third to return and one third in reserve.
2. Avoid fueling at night, except under well-lighted conditions.
3. Moor your boat securely to the dock. Know the location of the fire extinguisher in case of emergency.
4. Keep accurate records of your fuel consumption. A fuel log tracking fuel use over time will help determine average consumption.
5. Close all doors, hatches, windows and other compartments.
6. Extinguish cigarettes, pipes, and all other flame producing items.
7. Make sure all power is off, and do not operate any electrical switches.
8. Remove the fuel filler cap.
9. Close drain next to fuel fill.
10. Insert the hose nozzle and make sure nozzle is in contact with or grounded against fill opening. This will reduce the risk of static spark.

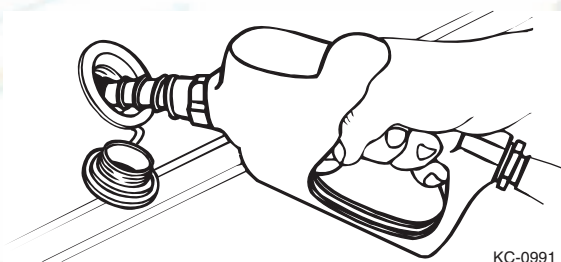

11. Add fuel in accordance with the propulsion unit operator's manual. Do not overfill, and allow enough room for fuel expansion.

The fuel cap is retained by a chain, to prevent losing the cap after it is opened. Be careful when fueling to avoid damaging the chain. If it breaks, have it replaced.

After Fueling:

1. Tighten the fuel fill cap using the fuel cap key. Wipe up any fuel spills.
2. Open drain next to fuel fill.
3. Open all windows, hatches, doors and compartments.
4. Check all fuel lines, hoses and connections for leaks and deterioration.

Launching

Launching Checklist

Federal and local laws require certain safety equipment to be onboard at all times. In addition, responsible boaters carry other equipment in case of an emergency. Check with local boating authorities for any additional requirements over and above federal requirements.

For maximum enjoyment and safety, check each of these items BEFORE launching:

- Have enough personal flotation devices for every person onboard.
- Be sure the steering system operates smoothly and properly.
- Verify the amount of fuel in the fuel tanks.
- Verify the batteries are fully charged.
- Check weather conditions.
- Be sure the lights, horn, bilge pumps and other electrical equipment are in proper operating condition.
- Be sure the fire extinguisher, signaling devices and other emergency gear are onboard and in proper operating condition.

On the Water

Start your engines before casting off. Remember, the boat turns from the stern. Allow plenty of space between the boat and the dock before trying to move away.



Boarding

When boarding the boat, always step on. Do not jump. Avoid stepping on fiberglass or other potentially slippery surfaces. Board one person at a time.

Do not board the boat while carrying gear. Set the gear on the dock, board the boat and then pick up the gear.

Loading

Do not overload your boat. The performance of your boat is dependent on load weight and distribution.

Maximum capacity for the tender with fluids, chocks and cradle is 700 lbs (318 kg) on the swim platform.

- Do not overload the swim platform.
- Securely stow all extra gear in stowage areas to prevent load shifting. Do not stow gear on top of safety equipment; safety equipment must be quickly accessible.
- Do not use any other part of the yacht for boarding the yacht from the water; use the boarding ladder. Make sure the engines are off when swimmers and divers are boarding or near the yacht.

Overloading of passengers, personal equipment and supplies could result in an accident, especially in rough waters. Maintain a balanced load at all times.

Shipshape

Keep the weight distributed evenly. Store all gear in secure areas. Safety equipment must be immediately accessible at all times.

DANGER

Avoid injury or death. All passengers should be carefully seated while the boat is moving. Do not sit on the bow, bow pulpit, deck, gunwale or sundeck pads when the boat is moving.

GETTING UNDERWAY

There are many things to consider when planning a safe and enjoyable boating trip.

You are responsible for the safety of all passengers, the boat and any damage the boat or its wake may cause. Keep passengers from blocking your view so that you do not run into other boats, swimmers, water skiers, personal water vehicles or aids to navigation.

Before Starting Checklist

The following checks are essential to safe boating and must be performed before starting the engines. Get into the habit of performing these checks in the same order each time so that it becomes routine.

Pre-Operation:

- Make sure you checked all the safety items listed in Cobalt Check List, in this section.
- Refer to *Section 6, Before Every Use*.
- Refer to **Launching Checklist**, in this section.
- Refer to Electrical Systems handbook.
- Test operation of carbon monoxide detectors.
- Check seawater strainers for leaks and accumulation of debris.
- Check that no fuel, oil or water is leaking or has leaked into the bilge compartment.
- Check all hoses and connections for leaks and damage.
- Check that the steering system operates properly.

DANGER

Avoid injury or death. Do not operate the boat if any problem is found during this inspection. A problem could lead to an accident when using an unsafe boat. Immediately have any problem attended to by your authorized Cobalt dealer.



During Operation:

- Check gauges or engine monitoring systems frequently for signs of abnormal operation.
- Check that steering, shift and throttle controls continue to operate smoothly.
- Check for excessive vibration.
- Monitor your fuel supply.
- Verify batteries are charged.

After Boating:

- Remove the ignition keys, if equipped.
- Stow and secure all equipment.
- Pump bilges dry with manual switch.
- Check for fuel, oil and water leaks.
- Clean any spills, stains or moisture from the boat. Inspect sea strainers.
- Remove any food, garbage and wet gear from the boat.
- Secure lockers, hatches and canvas as equipped.
- Refer to Electrical Systems handbook for storage procedures.

Zeus Propulsion System Operation

If your Cobalt yacht is equipped with the Zeus Propulsion System, pulling away from the dock, maneuvering and docking can be controlled by the Zeus system. Refer to the Zeus propulsion operator's manual for more detailed operation of the system.

Handling Dock and Mooring Lines

Be sure to use enough fenders to protect your boat from damage. Only use good quality double-braided nylon line. Protect your boat's finish by using chafing protectors on the lines. Only use the cleats to secure your boat. Do not use the handrails or windshield. If possible, tie up your boat with the bow toward the waves and leave a little slack in the lines to allow for some wave movement or tidal action.

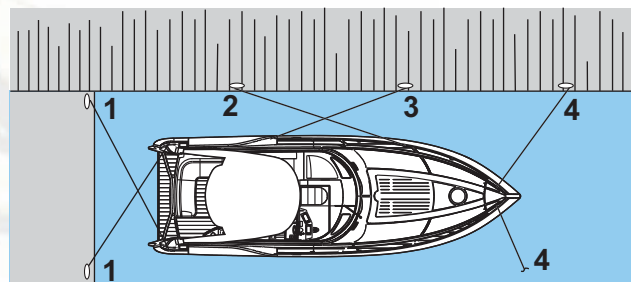

COB_0255_A

- 1 – Stern Line
- 2 – Forward Quarter Spring
- 3 – After Bow Spring
- 4 – Bow Line

Use your dock lines to help maneuver the boat near the pier and to secure it. Use the following information to secure your boat to a pile or dock cleat:

The bow line is fastened to the bow cleat and is pulled forward at about a 45° angle. This line keeps the boat from moving astern.

The stern line is fastened to an after cleat and pulled astern at about a 45° angle. This line keeps the boat from moving forward.

The spring lines can help you control the boat when leaving a dock. Be sure to use spring lines when boating in waters where the tide movement is significant. The forward quarter spring line is fastened to a forward cleat and heads aft. The after bow spring is fastened to a stern cleat and heads forward.



Starting/Shifting/Steering/Stopping

Your Cobalt yacht is equipped with a warning system that will sound an alarm if an engine problem develops. The horn may emit a short chirping sound during starting to verify operation. If the warning horn sounds when operating the boat, IMMEDIATELY throttle back to idle speed and shift into the NEUTRAL position. IMMEDIATELY check the gauges and stop the engines.



NOTICE: Continued operation after the warning alarm has sounded may cause severe engine damage.

Carbon Monoxide Detectors, if equipped

Avoid the possibility of injury or death from exposure to carbon monoxide (CO). All gasoline and diesel engines and fuel burning appliances such as heaters, stoves and generators produce carbon monoxide (CO). CO is colorless, odorless and dangerous. Direct and prolonged exposure to CO will cause brain damage or death. Signs of exposure to CO include nausea, dizziness, drowsiness, ears ringing, headaches, unconsciousness and cherry red skin color. Avoid exposing your passengers and yourself to carbon monoxide. Test the carbon monoxide detector operation before each trip, at least once a week and after the boat has been in storage. Do not tamper with the operation of the carbon monoxide detector. It is installed for your safety.

Carbon monoxide poisoning should not be confused with seasickness, intoxication or heat stress. If someone complains of irritated eyes, headache, nausea, weakness or dizziness, or you suspect carbon monoxide poisoning, immediately move the person to fresh air, investigate the cause and take corrective action. Seek medical attention if necessary.

Starting the Engines

⚠ DANGER

Avoid death, injury, fire or explosion. Operate the blower for at least four minutes each time you start the engines.

In addition, the blower should be operated continuously when at idle and during slow speed operation.

Cobalt Check List

For maximum enjoyment and safety, check each of these items

BEFORE you start your engine:

- PERSONAL FLOTATION DEVICES (One for every person onboard?)
- STEERING SYSTEM (Working smoothly and properly?)
- FUEL SYSTEM (Adequate fuel? Leaks? Fumes?)
- BATTERY (Fully charged?)
- ENGINE (In the NEUTRAL position?)
- WEATHER CONDITIONS (Safe to go out?)
- ELECTRICAL EQUIPMENT (Lights, horn, pump, VHF, etc.?)
- EMERGENCY GEAR (Fire extinguisher, anchor and line, signaling device, tool kit, etc.?)

RECOMMENDED SAFETY RULES

- REMAIN SEATED WHILE UNDERWAY.
- DO NOT USE BOARDING LADDER WHILE ENGINE IS RUNNING.
- TURN OFF MAIN ENGINES WHILE RE-FUELING.
- TURN OFF ENGINES WHEN SWIMMERS ARE NEAR BOAT.

After launching and pre-start checks and procedures have been followed, the engines can be started. Please refer to the propulsion unit operator's manual and Electrical Systems handbook for additional starting procedure information.



Shifting/Running

CAUTION

Avoid injury, swamping the boat or taking water in over the transom. Go slowly when traversing in reverse.

Follow these guidelines when shifting your boat:

- Pause in the NEUTRAL position before shifting from forward to reverse, or reverse to forward.
- Avoid shifting into reverse while the boat is traveling forward at speed.
- Keep the control area clean and clear of obstructions.

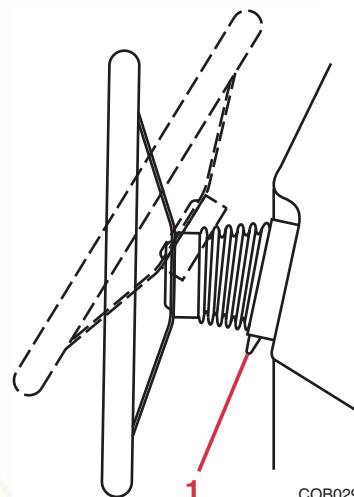

1 – Release Lever

Steering

! DANGER

Avoid injury or death. The steering system is the most important system in the entire boat from a safety standpoint. Propeller torque, trim setting, water condition and boat speed affect the steering. Constant attention to the steering system is required for safe operation. Have the system inspected and maintained on a quarterly basis by a qualified service technician.

Your Cobalt yacht is equipped with a tilt steering wheel. Adjust the tilt position by pressing the lever and adjusting to a comfortable position.

! WARNING

Avoid loss of control and/or injury. Do not adjust the steering wheel tilt position while the boat is moving. Sudden boat movement may cause loss of balance resulting in loss of control.

The steering system must be working correctly and properly maintained. Be sure to:

- Keep mooring lines, tow lines and other obstructions clear of the steering system.
- Keep the steering system's moving parts clean and lubricated.
- Regularly inspect the steering system for kinks, damage and corrosion.

Refer to **Basic Maneuvering**, in this section, for additional steering information.

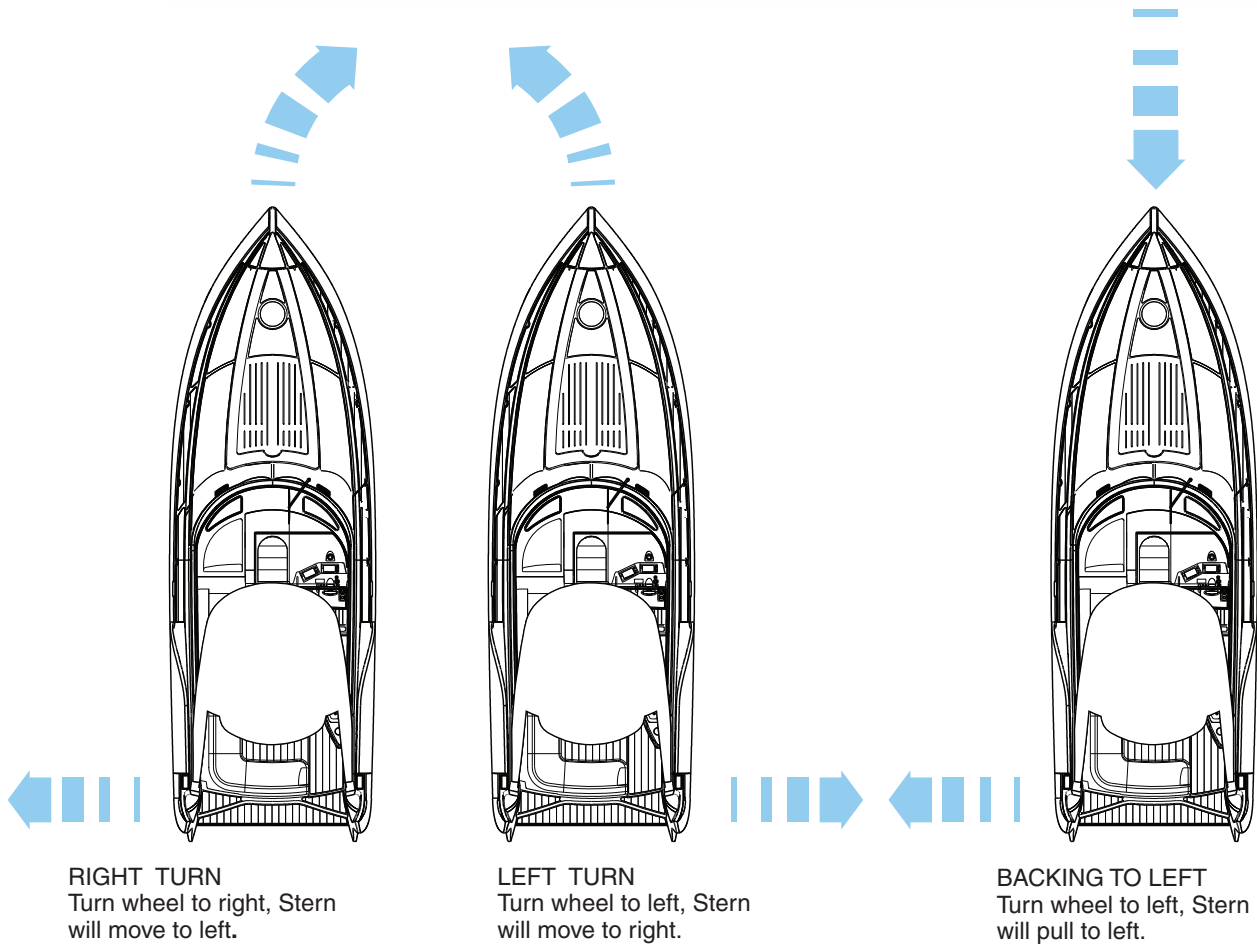

COB_0192_A



Stopping the Engines

WARNING

Avoid creating a hazardous condition. Do not use the engine stop switch and lanyard for normal stopping of the engines. Using the stop switch will impair your ability to restart the engines quickly if a hazardous situation arises.

1. Slowly bring the throttle levers to the IDLE position.
2. Make sure the transmissions are in NEUTRAL.
3. After operating at high speeds, allow a 2-3 minute engine cool-down period at low idle.
4. Turn the ignition OFF.



NOTICE: If any problems are encountered during the outing, have your boat inspected by your authorized Cobalt dealer and request any necessary repairs before your next outing.

Leaving

Use caution when casting off. Wind, water conditions and other boat traffic will affect your boat's movement. Move slowly and:

- Be sure the engines are warmed-up before casting off.
- Have enough space between the boat and the dock to allow you to swing the boat's bow away from the dock. The boat's stern will move toward the dock as the bow moves away. Allow for enough room or the stern will hit the dock.
- Retrieve all mooring lines and fenders.
- Proceed slowly. Sound a long blast to alert other boaters that you are departing.

When leaving a mooring, you should already have enough space around the boat to maneuver. Untie from the mooring and move back slowly until you can see it. Proceed slowly while giving the buoy wide clearance.

Returning

WARNING

Avoid injury. Do not use your hands, arms or another part of your body to attempt to keep the boat from hitting the dock.

Approach a dock slowly and use caution. Plan your maneuvers ahead of time. Allow wind and current movement to help maneuver your boat.

Be sure to read **Basic Maneuvering**, in this section.

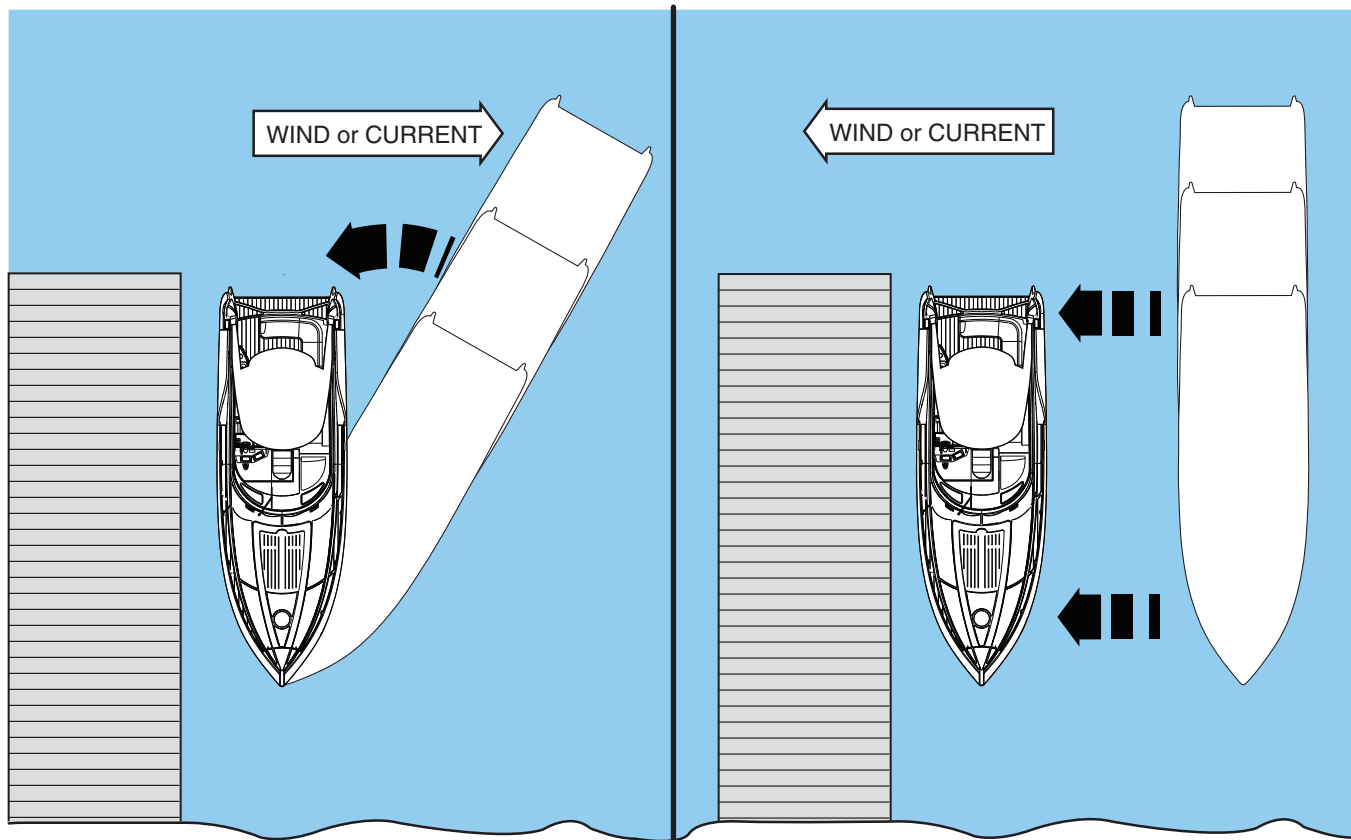

COB_0193_A

Docking

Follow these guidelines when docking:

- Come to a stop a short distance from the dock, then proceed slowly.
 - Have your fenders, mooring lines and the crew ready.
 - Observe how the wind and current are moving your boat. Approach the dock with the boat pointed into the wind, if possible. If the wind or current is pushing you away from the dock, use a sharper angle of approach. If you must approach the dock downwind or down current, use a slow speed and shallow angle. Be ready to reverse in order to stop and maintain position.
- If there is no wind or current, approach the dock at a 10° to 20° angle.
 - If possible, throw a line to a person on the dock and have that person secure a bow line. If no one is on the dock, maneuver as close as you can, then secure any line to a piling or dock cleat.
 - With the bow secure, swing the stern in using engine thrust, or pull it in with a boat hook.



Approaching a Slip

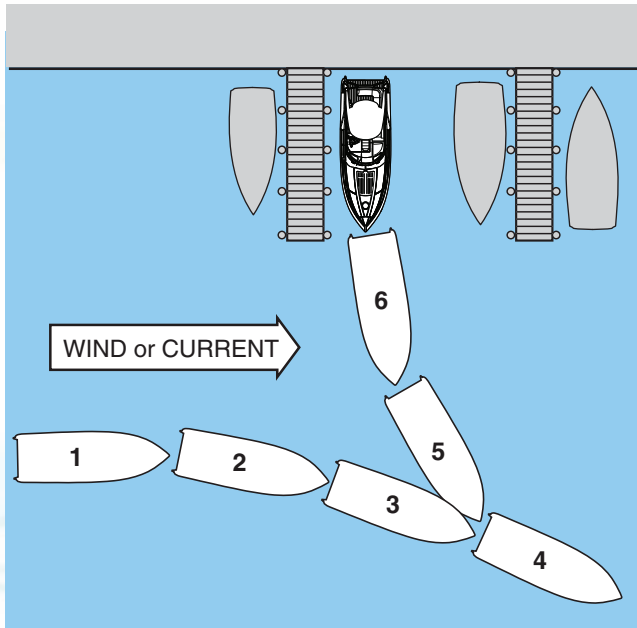

COB_0194a_A

This maneuver is similar to backing an automobile into a garage or parking space. All the above can be completed using the joystick control. Refer to the Zeus propulsion operator's manual for more detailed operation of the system. When approaching a slip:

- When possible, maneuver against the wind and current, not with them.
- Have fenders, mooring lines and the crew ready.
- Secure the mooring lines and stop the engines.

Approaching a Mooring



COB_186_A

1 – Mooring Buoy

The only buoys you are permitted to moor to are mooring buoys. Mooring to a navigation buoy or other navigational aids or regulatory marker is illegal.

Approach a mooring buoy by heading into the wind or current. Observe the direction of other boats that already lie at mooring buoys. Since they are heading into the wind or current, approach your buoy at the same heading.

- When you think you can move enough forward without using your engines, shift to the NEUTRAL position.
- Have a crew member positioned on the bow with a hook to retrieve the mooring line. At that point, the crew member should be guiding your maneuvers toward the buoy.
- Turn off the engines after the mooring line is attached to the boat.

Basic Maneuvering

Techniques

Wandering is a characteristic of all deep V-hulls at slow speed. There is no cure for wandering; however, a very basic operational technique can be applied which will minimize this characteristic.

If the steering wheel is moved back and forth to compensate for wandering, invariably, the situation will be magnified. If the steering wheel remains in a centered position, the boat will wander back and forth slightly; however, the overall course of the boat will be a straight one.



Trim

Boat trim while on plane is influenced by three factors:

1. Load weight
2. Load distribution
3. Trim tab position

Determining best boat trim while underway takes time. It is best to experiment with different tab trim combinations while taking note of the condition.

Load Distribution

The performance of your Cobalt yacht depends on load weight and distribution.

Distribute weight evenly, from bow to stern, and also from port to starboard.





Trim Tabs

Your Cobalt does include indicators on the Smart Craft screen to show position of the tabs and drive units.

Trim tabs on Zeus propulsion include an automatic trim tab system. These tabs can also be operated manually from the dash switch. Refer to the Zeus propulsion operator's manual for more detailed operation of the system.

Water is deflected and redirected as the trim tabs are raised and lowered. This change in the water flow creates upward pressure under the tabs, and raises the stern. When the stern raises, the bow lowers. Likewise, lowering the port tab will cause the port stern to raise, making the starboard bow lower.

Using trim tabs will compensate for uneven weight distribution, listing, water conditions and other factors that cause inefficient operation.

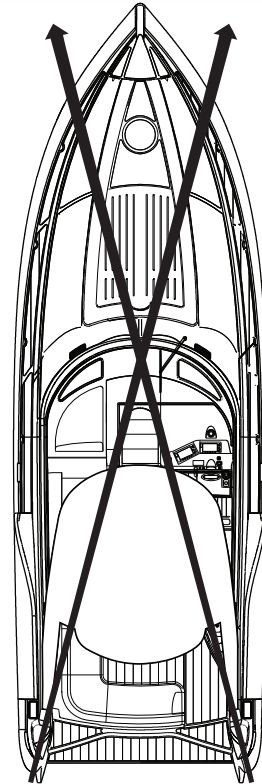

PORT TAB LOWERED

- PORT STERN RISES
- STARBOARD BOW LOWERS

STARBOARD TAB LOWERED

- STARBOARD STERN RISES
- PORT BOW LOWERS

COB_0195a_A

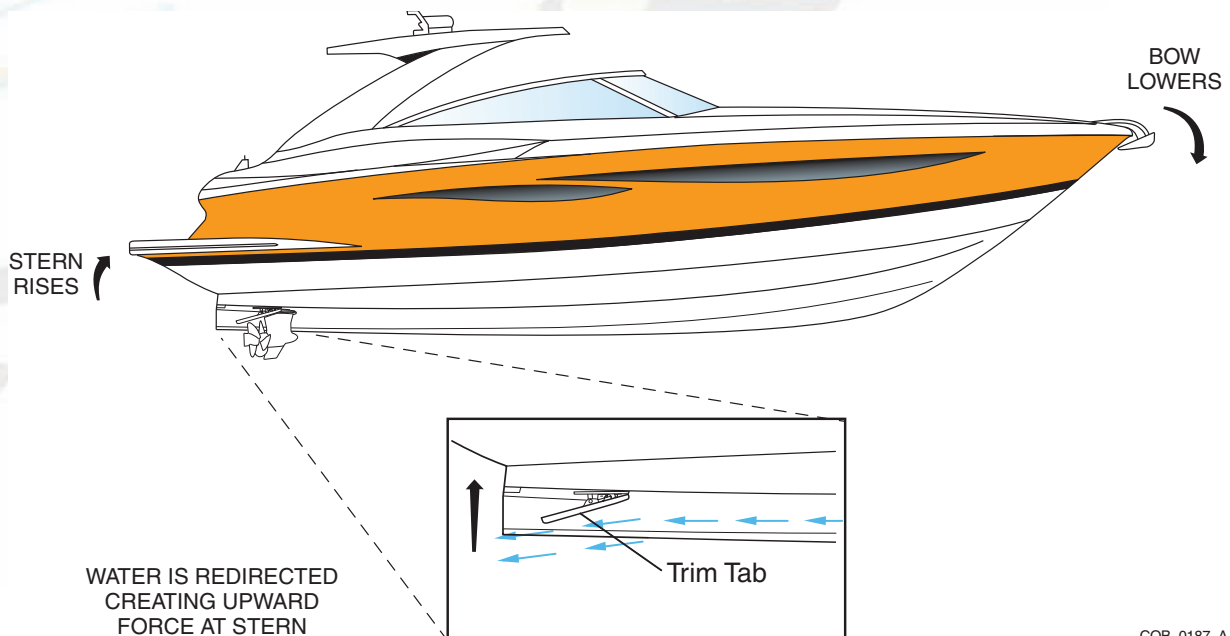

COB_0187_A



DANGER

Avoid injury or death. Use the trim tabs slowly to adjust trim. Adjustments are not immediate. Improper use of the trim tabs at high speeds can cause an accident.

Slow Speed Operation

When operating your Cobalt yacht at low speeds, use the Zeus joystick. The Zeus Drive is a “drive-by-wire” system. Your owner’s packet contains detailed operating instructions.

High Speed Operation

DANGER

Avoid injury, death or property damage. Sudden turns may cause loss of control. When crossing another boat’s wake, throttle back to prevent damage to your boat and/or injury to its occupants. Also, damage to the boat could take place causing a hazardous condition.

When operating any boat at high speed, exercise a great deal of caution. This is particularly true during turns. Gradual turns can be completed at high speed by a competent driver, but it must be emphasized that sudden turns at any speed, and particularly at high speed, can be especially dangerous. It is possible to throw passengers from their seats and even from the boat if caution is not exercised. Remember, common sense is the rule for safe boating.

We recommend that you have 10 hours of experience with the boat before any full throttle operation. Do not operate your boat until you are completely experienced with its handling characteristics. The following are some guidelines for performance operation.

- Keep bottom of the hull clean and free of barnacles and other growth. Growth on the hull can slow the boat down considerably.
- Prepare the boat. Be sure all gear is properly stowed and compartments are latched.

- Weight distribution affects performance. Keep weight in the boat to a minimum and evenly distributed.
- The propellers should be of the proper pitch to turn the recommended RPM rating for the engine with an average boat load. Refer to your propulsion unit operator’s manual for additional information.

DANGER

Avoid injury, death or loss of control. Keep one hand on the steering wheel and the other on the throttle controls at all times. If the boat begins to operate in an unsafe way, pull back on the throttles.

High-speed operation on smooth water is very stable, but quick reactions and adjustments are needed to maintain control. Know your limits and stay within them. Keep one hand on the steering wheel and the other on the throttles; constant adjustments are necessary for rapidly changing conditions. Small inputs of throttle, steering and trim movement are exaggerated at high speeds. Keep watch well ahead so that you have enough time to react.

Anchoring

WARNING

Avoid injury, death or swamping. Anchor from the bow, not from the stern. A strong current can pull a boat underwater, anchored by the stern, and keep it there.

Be sure the anchor is adequate for your boat. Use caution when anchoring. Look for signs of underwater pipes or cables. With the engines off, you have no control of the boat. Water and wind conditions will affect an anchored boat. Be sure the anchor will hold before leaving the boat.



There are many types of anchors available on the market. The choice of one anchor over another depends on many factors. An anchor will usually hold best in a mixture of mud and clay or in hard sand. A Danforth anchor is recommended for general boating. For more information on anchors, contact your authorized Cobalt dealer.

The windlass anchoring winch gets its power from the 12 V DC system. The windlass can be operated at the driver's helm (indicator light must be illuminated) or from the foredeck. There are foot-operated switches located under the anchor locker door.

The windlass system can also be operated manually. On the anchor locker lid on the foredeck, you will find a crank.

Please consult the operator's manual supplied with the windlass system for proper operation of the system in the electric and manual modes.

The windlass circuit breaker, located in the engine compartment, must be in the ON position. When not in use, turn the circuit breaker to the OFF position.

Use caution when anchoring. Look for signs of underwater pipes or cables. With the engines off, you have no control of the boat. Water and wind conditions will affect an anchored boat. Be sure the anchor will hold before leaving the boat.

Lowering

Bring the boat to a stop with the bow facing into the wind or current. Lower the anchor. On dash control, place safety switch in the ON position.

Press and hold the toggle switch down to pay out sufficient chain to set the anchor.

Setting

When the anchor hits bottom, slowly back up the boat, keeping tension on the line. The anchor line should be five to seven times the depth of the water.

Weighing

To weigh (retrieve) the anchor, start the engines and slowly move forward. Press the toggle switch up while taking in anchor line as you go. Carefully retrieve the last meter (36 inches) of chain, then seat the anchor in the bow fitting. Secure the anchor with chainstop or securing device.

Refer to the windlass operator's instructions for additional operating information.

Towing

Cobalt Yachts does not recommend towing your yacht. If a towing need arises, enlist a professional towing service to tow your yacht.

Entertainment System

Your Cobalt yacht is equipped with a wide array of top quality entertainment systems for your enjoyment, including an LCD Flatscreen TV w/Surround Sound and a Stereo/CD/DVD/MP3. To operate your entertainment system, you must first supply power to the unit(s). For additional operating information, refer to the operator's manual for your stereo and accessories supplied to you in your owner's packet.

For a list of what is standard for your entertainment system, refer to Standard and Optional Equipment in this section.

WARNING

Avoid injury and/or property damage.

- **Keep hands, feet, loose clothing and hair well clear of the winch and rope/chain during operation.**
- **Keep clear view of the winch when operating it.**
- **Run the engines of the boat while raising or lowering the anchor. Not only is this a safety precaution, it also prevents draining of the batteries.**
- **Secure the anchor with chainstop or securing device when operating the boat at high speed, in heavy weather or while transporting.**
- **Turn the WINDLASS switch off when the winch is not in use and before leaving the boat.**



HELM AND INSTRUMENTATION

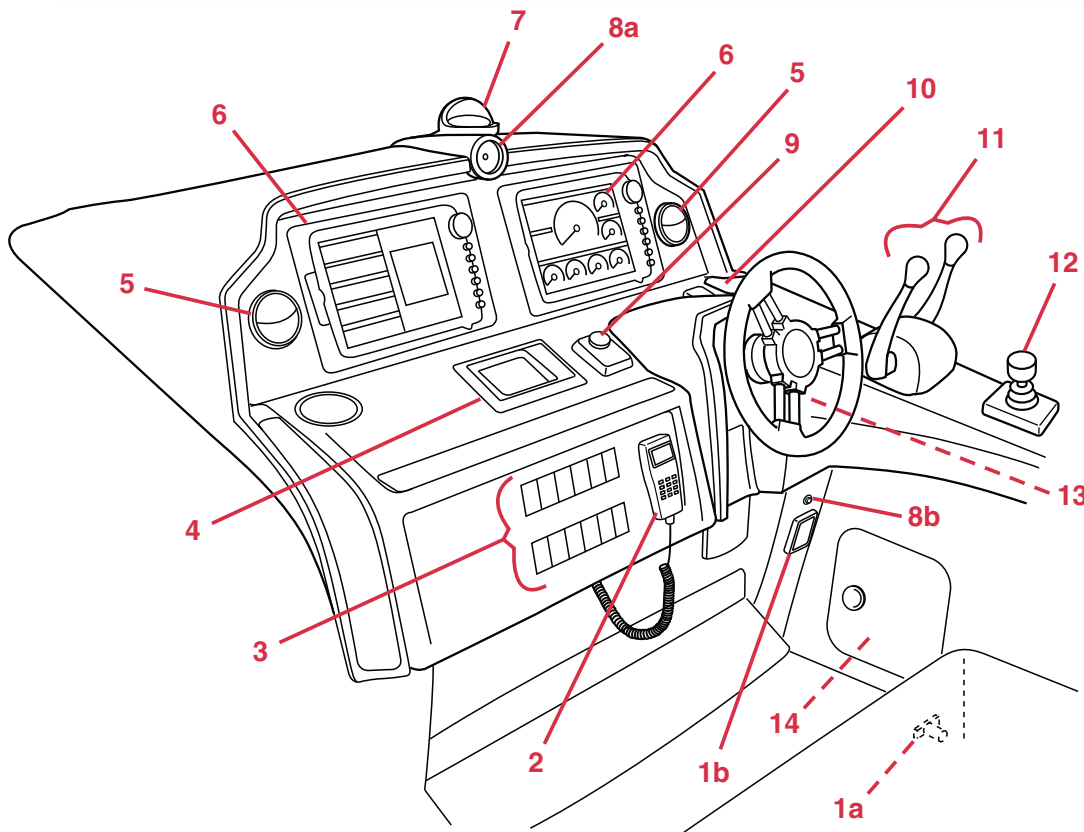

COB_0182_A

Your Cobalt yacht helm will monitor and provide operation of the yacht functions. Engine monitoring systems will monitor functions of the engines and provide precise readings and indications. Refer to the engines monitoring systems user's manual supplied in your owner's packet for operating information. Some models are equipped with gauges. The gauges are illuminated for night operation. When the switches are activated, the LEDs will illuminate if the switch is ON. LEDs will be blue when inactive, green when activated and red during a fault.

On occasion, a small fluctuation in a gauge reading is not unusual. If an instrument reading is outside the normal or recommended ranges, determine the cause or see your authorized Cobalt dealer. Refer to the engine operator's manual for normal recommended ranges.

WARNING

Avoid the risk of injury, death or equipment damage. If the safety of you or others depends on running the engine during an abnormal condition, make the right decision on saving equipment or lives. Do not jeopardize the safety of you or others to protect your yacht.



1a. Manual Discharge for Automatic Fire Suppression System - This control allows you to override the automatic fire suppression system in case of emergency. To override the automatic fire suppression system, remove pin and pull handle.

1b. Fire Suppression System Monitor - Monitors the automatic fire suppression system. The monitor will display when the system is powered, discharged and allows the system to be overridden. For additional information, refer to the fire suppression system operating instructions in your owner's packet.

2. VHF Marine Radio - Allows communication between boats and between a boat at sea to public and private shore stations. For operating information, refer to the radio owner's manual in your owner's packet.

3. Switch Panel and Functions - The switches will function as labeled.

FWD/MID/AFT BILGE - FWD (Fore Bilge Pump), MID (Mid-ship Bilge Pump), AFT1 (Fwd Aft Bilge Pump), AFT2 (Aft Bilge Pump). These switches manually control the designated bilge pump.

BLOWER - Blowers will turn on with the ignition switch. The blowers can also be turned on or off with the switch at the helm. The purpose of the blowers is to circulate air within the engine compartment.

WIPER - Activates the windshield wiper.

WASHER - (Windshield Washer Switch) Sprays windshield washer fluid. The windshield washer fluid reservoir is located under the captain's chair.

ACCY (Accessory) - This switch is available to operate a switched accessory item. When the switch is pressed, the accessory will receive power.



NOTICE: DO NOT connect an accessory drawing more than 10 amps to the accessory switch. A hazardous situation or damage to the electrical system can occur.

CABIN/ENG RM/COCKPIT/DECK/ARCH/ HELMLT - These switches operate the designated lights within the yacht.

HORN - This switch activates the horn. Press the switch to activate.

NAV/ANC "Lights" (Navigational Lights) – This three-position switch activates the navigational (running) lights and the anchor light.



NOTICE: Operate the boat between sunset and sunrise using your navigational lights. Navigational lights are legally required to indicate direction and right-of-way at night.

Navigational Lights - You must use your navigational lights (running lights) when operating your yacht between sunset and sunrise, and when day time visibility is limited. Also, check with the local authorities before operating your yacht for other requirements concerning the use of navigational lights.

The navigational lights are identified by a red light on the port side of the vessel, a green light on the starboard side, the forward half of the masthead light and the aft facing stern light.

ANCHOR/MOORING LIGHT - All boats at anchor or moored must display a proper white anchor light.

The anchor light (masthead light) is the white light located on mast, on the hardtop. The anchor light must be visible from 360°.

WINDLASS - Provides power to the windlass system.

▲WINDLASS / ▼WINDLASS - Windlass Up/Down Operation. The windlass system can be electronically operated from the helm. For operation of the windlass system, refer to Anchoring, in this section.

↑HATCH / ↓HATCH - Engine Hatch Switch, activates the engine compartment hatch electronic lift system. The positioning of the transom door will prevent the activation of the engine hatch switch. The engine hatch switch will not work unless the transom door is latched open. If the battery is low or disconnected, the bilge area can be accessed through the day hatch located in the aft cockpit.

STBD/EMERG/PORT/HOUSE BATTERIES - These switches activate the designated batteries. The emergency battery switch should be reserved for an emergency situation, in the event the other batteries are drained and will remain energized for 10 minutes without indication.

GEN START/GEN STOP - This switch allows the generator to be started and stopped at the helm. Press and hold the switch until the generator starts. There may be a time delay of up to 20 seconds. Refer to the generator owner's manual in your owner's packet for more detailed operating information.

4. Smart Craft Display Screen - Refer to the Mercury Smart Craft owner's manual in your owner's packet for operating information.

5. Air Conditioner/Heater Ducts - These ducts are directional or can be closed.

6. Northstar Chartplotter - Refer to the Northstar user's manual supplied in your owner's packet for operating information.

7. Compass - To aid in navigation, your Cobalt yacht has a compass mounted at the helm. Refer to the compass user's manual supplied in your owner's packet for operating information. The compass may require to be compensated; consult your Cobalt Dealer for further information.

8a. Clock

8b. Clock Set

9. Search Light Remote Control - Electrically controls the search light from the helm. Refer to the searchlight user's manual supplied in your owner's packet for operating information.

10. Engine Start/Stop Switch - Each engine has its separate start/stop. The left switch is for the port engine, and the right switch is for the starboard engine.

Precision Pilot Control - Refer to the Precision Pilot user's manual supplied in your owner's packet for operating information.

11. Throttle Controls -



NOTICE: Do not shift too quickly from forward to reverse. Damage to the engines and transmissions can result. When shifting from forward to reverse, pause in neutral until the engines are at idle speed and the boat has slowed. Your Cobalt yacht is equipped with a safety switch for "start-in neutral-only."

Always keep one hand on the steering wheel and the other on the throttle levers at all times. The following information relates to the general description about your controls. Refer to the engine operator's manual or the control operator's manual for specific use.

Your controls have individual levers for each engine's throttle. The port lever is for the port engine and the starboard lever is for the starboard engine. If the engines are shut down above idle, return the throttle controls to idle before starting the engines.

12. Zeus Propulsion System Joystick - Refer to the Zeus propulsion operator's manual for more detailed operation of the system.

13. Tilt Steering Release Lever



14. Ignition Switches and 12-Volt Port

Helm



Aft Cockpit

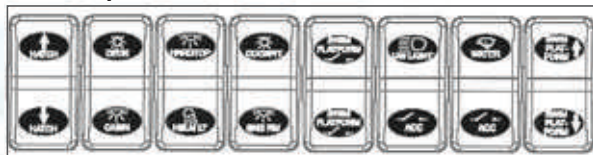

COB_0272a_A

Aft Cockpit Entry Switch Panel

This panel is part of the E-Plex system. It controls functions within the cockpit and features which must be operated from the cockpit. This switch is located on the starboard, aft side, as you enter the cockpit.

SWIM PLATFORM POWER - This switch supplies power to the hydraulic PWC lift / swim platform. Do not press and hold. This switch will only be active when both ignition keys are in the OFF position. The switch blinks red when it is active. **MAKE SURE** the platform is clear of passengers before continuing operation.

UW LIGHTS / ACC - This switch supplies power to the underwater transom lights and a designated accessory.

RAW WATER / ACC - This switch supplies power to the raw water pump and a designated accessory.

↑SWIM PLATFORM / ↓SWIM PLATFORM - This switch raises and lowers the swim platform. The **SWIM PLATFORM POWER** switch must be activated for this switch to operate.

↑HATCH / ↓HATCH - This switch activates the engine compartment hatch in the same manner as the **HATCH** switch at the helm, but can be accessed from the cockpit. The positioning of the transom door will prevent the activation of the engine hatch switch. The engine hatch switch will not work unless the transom door is open. If the battery is low or disconnected, the bilge area can be accessed through the day hatch located in the aft cockpit.

AFT DECK / CABIN - This switch supplies power to the aft deck and cabin lights.

HARDTOP / HELM LT - This switch supplies power to the hardtop and helm lights.

COCKPIT CRTSY / ENG RM - This switch supplies power to the cockpit courtesy and engine room lights.



E-Plex System Switches

Helm



Aft Cockpit

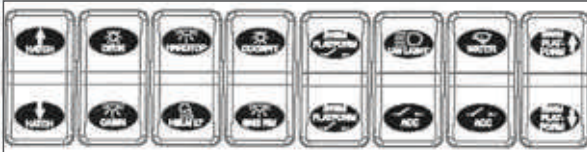

COB_0272a_A

These switches are located at the helm and in other locations in the cockpit. The LEDs will be blue when supplied power and inactive, green when active and red during a fault.

E-Plex System

E-Plex is an electronic distribution system versus a conventional power distribution. The E-Plex system consists of easy-to-use, touch-screen, power distribution modules, machine interface modules, sensors and software. These components electronically connect engines, generators, lighting, HVAC, audio/video and other equipment. The result is a seamless monitoring and control solution with dramatically increased system functionality.

The E-Plex system essentially replaces all the functions of a conventional power distribution panel. Refer to the E-Plex operator's manual and the E-Plex System handbook for more detailed operation of the system.



CAPTAIN'S CHAIR ADJUSTMENTS AND OPERATION

Your captain's chair has the flip-up bolster position for greater visibility and maneuverability while docking. You can sit on the raised cushion or stand in front of the cushion.

Standing while driving your boat should only be done while maneuvering at an idle by an experienced driver.

The captain's chair can be adjusted fore and aft. Pull the lever beneath the seat and slide the seat fore or aft. Make sure the seat is rested in its detent before getting underway.

DANGER

Avoid potential injury or ejection of occupants. Do not stand while driving above engine idle speeds and make sure all passengers are seated and seats are in a locked/secured position when the boat is underway.

SWIM PLATFORM/ BOARDING LADDER

DANGER

Exposure to carbon monoxide will cause death or serious injury. DO NOT use the boarding platform for any other purpose than boarding the craft or preparation of entering the water or as a PWC lift. DO NOT use the boarding platform when the engine is running.

Use the release lever to release the ladder and telescope to full length. Rotate ladder to retract and stow. Make sure the ladder is in the locked position before using. Use caution when stowing the ladder to prevent pinching fingers.

Make sure there is no one in the area behind the boat and the boarding ladder is properly stowed before starting the engine and engaging the shift mechanism.

PWC LIFT/SWIM PLATFORM

DANGER

Exposure to carbon monoxide will cause death or serious injury. DO NOT use the boarding platform for any other purpose than boarding the craft or preparation of entering the water or as a PWC lift. DO NOT use the boarding platform when the engine is running.

WARNING

Crush and/or cut hazard from occupying the boarding platform when it is in motion. DO NOT occupy the platform when it is in motion.

The PWC Lift/Swim Platform is designed to lift many types of tenders and/or personal watercraft, as well as a swim/boarding platform. The platform consists of two telescoping lift assemblies, with internal hydraulic cylinders that lower and raise the system. To operate the lift/swim platform and to activate the power button, the ignition keys must be turned off. There is a thirty second delay after the ignition switches are turned off before platform will operate. From raised position, press "up" arrow to release catch latches, then operate as desired. The power button will turn itself off after four hours. When activated, a red light will blink indicating the swim platform can be used. Operate the swim platform using the directional toggle switch. A slight delay is normal. Make sure all passengers are off the platform and the cockpit door is closed. **DO NOT ALLOW ANY PASSENGERS ON THE PLATFORM WHEN IT IS IN MOTION.**

Maximum platform weight capacity is 700 pounds (317.5 kg).



COCKPIT DINETTE TABLE

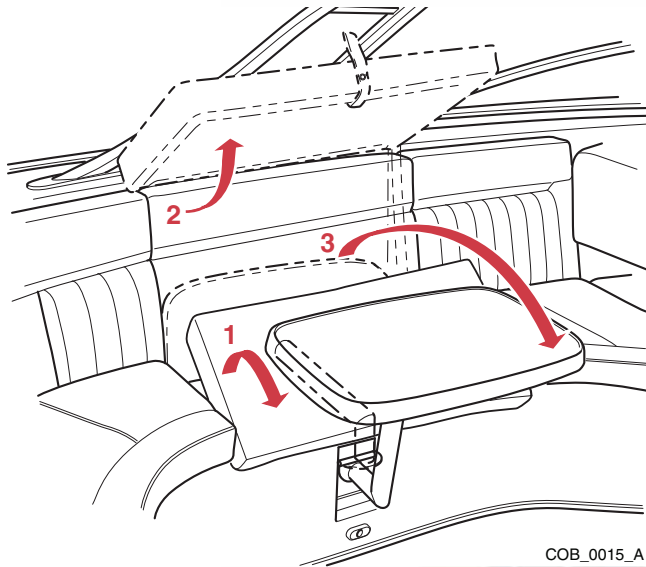

To access the cockpit dinette table:

1. Lift and remove the table seat cushion.
2. Lift the seat back to access table.
3. Lift the table top from its stowed position and lower the table into position.

Return the seat cushion by placing the front of the seat cushion in position.

To return the table to its stowed position, reverse the previous steps.

FOREDECK SUN PAD

⚠ WARNING
DROWNING HAZARD
Occupying foredeck sun pad while the boat is underway can result in death by drowning or serious injury. DO NOT occupy the foredeck sun pad while the boat is underway.

Slide the sun pad into the forward holder and secure the straps to the two hand rails to hold the pad in position.

CARBON MONOXIDE DETECTOR

Carbon monoxide detectors are located throughout the yacht in primary berthing areas, such as the salon and staterooms. The detectors receive power from the 12V DC system. The detectors will be operational any time the battery power is on. If occupying the yacht, make sure power is supplied. The green light on the detector may flash for 15 minutes while it warms up; however, it is fully functional. If the unit alarm sounds, evacuate all persons from the cabin area to fresh air immediately and investigate the cause. Do not return to the cabin area until the cause of the CO has been identified and corrected. For additional information, refer to the carbon monoxide detector operating instructions in your owner's packet.

⚠ DANGER
Avoid the possibility of injury or death from exposure to carbon monoxide (CO). All gasoline and diesel engines and fuel burning appliances such as heaters, stoves and generators produce carbon monoxide (CO). CO is colorless, odorless and dangerous gas. Direct and prolonged exposure to CO will cause brain damage or death. Signs of exposure to CO include nausea, dizziness, drowsiness, ears ringing, headaches, unconsciousness and cherry red skin color. Avoid exposing your passengers or yourself to carbon monoxide. Test the carbon monoxide detector operation before each trip, at least once a week and after the boat has been in storage. DO NOT tamper with the operation of the carbon monoxide detector. It is installed for your safety.



A carbon monoxide (CO) detector will only detect the presence of carbon monoxide gas at its sensor and will not detect other vapors such as gasoline. Carbon monoxide may be present in other areas. Carbon monoxide poisoning should not be confused with seasickness, intoxication or heat stress. If someone complains of irritated eyes, headache, nausea, weakness or dizziness, or you suspect carbon monoxide poisoning, immediately move the person to fresh air, investigate the cause, and take corrective action. Seek medical attention if necessary.

SPOTLIGHT

All functions of the spotlight can be electrically operated by remote control from the helm using the remote control panel. For additional information, refer to the spotlight operating instructions in your owner's packet.

SALON ACCESS DOOR

DANGER

Avoid the possibility of injury or death from exposure to carbon monoxide (CO). All gasoline and diesel engines and fuel burning appliances such as heaters, stoves and generators produce carbon monoxide (CO). CO is colorless, odorless and dangerous. Direct and prolonged exposure to CO will cause brain damage or death. Signs of exposure to CO include nausea, dizziness, drowsiness, ears ringing, headaches, unconsciousness and cherry red skin color. Avoid exposing your passengers or yourself to carbon monoxide. Check the CO detectors before every outing and keep the cabin door closed when running the engines or a generator. Keep the cabin and cockpit areas well ventilated and do not block exhaust outlets.

The sliding cabin access door should not be open when the boat is underway, since an open cabin door can create a vacuum. Make sure the door is secured when it is opened or closed, and do not allow it to slide free.



NOTICE: Secure the door when underway. Do not sit, stand or place heavy objects on the door. Unlock and remove the key to avoid breaking, unless leaving the boat. Do not use caustic materials or a dry rag to clean the door. Use only a mild soap and water.

ELECTRIC ADJUSTABLE AND EXTENDABLE SALON TABLE - OPTIONAL

The salon table height can be adjusted by pressing the TABLE "UP" or "DOWN" arrows on the E-Plex salon panel. DO NOT continue to operate adjustment arrows when the table is fully extended or retracted. Always protect the table top when it is being used.

APPLIANCES

Your yacht is equipped with an array of appliances which require 110V AC power from shore power or from the generator. The power and protection for all of the appliances are monitored and controlled through the E-Plex control panel. To activate any appliance, the E-Plex must be energized. For more detailed information on appliances, refer to the respective owner manual in your owner's packet.

WATER/HEATER TANK

Your yacht must have water in the water system and the water pump on, pressurizing the system to avoid damaging the water heater element. To operate the water heater, the system must be energized at the E-Plex panel. The water heater requires 110V AC from shore power or from the generator.



The hot water system and the entire freshwater system in your Cobalt yacht must be winterized for proper storage. For detailed information on the water heater, refer to the water heater operator's manual instructions in your owner's packet.

DANGER

EXPLOSION OR FIRE HAZARD

Explosion or fire hazard from hydrogen gases produced by non-use of water heaters will cause death or serious injury. DO NOT smoke, have any open flame or turn on any appliances near an open faucet until water flows from the system or air sounds disappear.

Water heaters not used for more than two weeks may produce hydrogen gas. To reduce the risk of injury under these conditions, open the hot water faucet for several minutes at the kitchen sink before you use any electrical appliance connected to the hot water system.

If hydrogen is present, you will normally hear unusual sounds, like air escaping through the pipe as water begins to flow. Allow the water to flow until these sounds disappear.

MICROWAVE/ COFFEEMAKER

The microwave and coffeemaker unit is concealed and can be accessed by activating MICROWAVE on the galley control panel. The microwave requires 110V AC from shore power or from the generator. If either appliance is on, the unit will not lower. For additional information, refer to the microwave operating manual in your owner's packet.

SALON REFRIGERATOR/ FREEZER

The thermostat control is located on the front panel of the units. The refrigerator/freezer requires 110V AC/12 volt from shore power or from the generator. For additional information, refer to the refrigerator operator's manual in your owner's packet.

COCKPIT REFRIGERATOR

The thermostat control is inside the refrigerator. The refrigerator/freezer requires 110V AC from shore power or from the generator. For additional information, refer to the refrigerator operator's manual in your owner's packet.

STOVE

The cabin-mounted, dual burner stove is electric. The stove requires 110V AC from shore power or from the generator. For additional information, refer to the stove operator's manual in your owner's packet.

TELEVISION AND ENTERTAINMENT SYSTEMS

The entertainment systems within your yacht can be operated from the 12V DC system, or 110V AC from shore power or from the generator. Make sure power is supplied through the E-Plex control panel. For additional information and features, refer to the respective entertainment system operator's manual in your owner's packet.



CABIN DISTRIBUTION PANEL

DANGER

Avoid fire, explosions, electrocution, injury or death.

- **Use the electrical system properly.**
- **Do not work on an energized system.**
- **Avoid swimming near the boat when it is connected to shore power.**
- **Use caution when connecting or disconnecting to shore power.**
- **Do not reset a circuit breaker which has been automatically tripped without first detecting and correcting the cause of the problem.**
- **Connect shore power cable at the boat first.**
- **Disconnect shore power cable at shore outlet first.**
- **If reverse polarity light is activated, immediately disconnect shore power cable.**
- **Do not alter shore power cable connections.**
- **Close shore power inlet cover tightly.**

Your yacht is equipped with two electrical systems; a battery powered direct current (DC) system, and shore powered alternating current (AC) system. The generator can also provide AC current when away from shore power.

These systems have a load center panel which serves as the main distribution panel.

The entire electrical system is essentially controlled and monitored through the E-Plex system. The power distribution panel is located in the salon, behind the forward facing couch, on the starboard side.

ELECTRICAL

The DC system supplies electricity to all of the electrical circuits on the yacht (lights, pumps, blowers, ignition, etc.).

The AC system supplies electricity to all of the AC-powered electrical circuits on the yacht (electrical outlets and to AC-powered systems) when the yacht is moored, moored to a dock or slip, through shore power, or from the generator.

Multiple batteries serve as starting batteries for each engine. Four batteries are used in parallel for 12-volt house power. The house battery starts the generator.

There is a battery charger for the house and starting batteries. The battery charger is powered by either the dockside or generator 120V AC power. The main engines charge their own respective bank and the house battery.

The three battery banks (port, starboard and house) are isolated from each other. The emergency crossover switch will combine all three banks as a single bank.

DC Electrical

Your yacht has a 12-volt negative ground DC system. The positive wire is hot, and feeds current from the batteries to all 12-volt equipment; the negative wire is the ground.

Once again, all functions are controlled by the E-Plex system.

AC Electrical

When the shore power cord is plugged in, all AC equipment can be operated.

The shore power cord supplies power to the cabin distribution panel, which essentially powers the E-Plex system.

The 110V AC system consists of inlet breakers and a shore/generator selector switch within the E-Plex system in the cabin. The E-Plex system contains a voltmeter, ammeter, main circuit breaker and a series of switches.



The AC portion of the E-Plex system receives AC power from the shore power cable or generator. The panel distributes AC power through main circuit breakers.

AC electricity operates the equipment displayed on the cabin 10" display.

Amperage is displayed digitally on the 10" display. This allows you to check for proper voltage and polarity immediately after making the shore power cable connection. The reversed polarity light indicates if the polarity of the shore power has been reversed.

Battery Switches

There are three Battery switches and two Emergency Parallel Switches. The House battery switch is located port forward in the engine room. The engine battery switches and Emergency Parallel Switches are located in the forward battery compartment below the floorboard between the engines. For operation in "Automatic" mode, the battery switch must be turned to "OFF" first, then into "Automatic." These switches are normally operated by E-Plex at the dash or on cabin 10" display but they can also be operated manually by turning the red switch on top.



NOTICE: To prevent accidental operation, the battery switches must be pressed for two seconds to turn off.

Shore Power Connection

⚠ DANGER

Avoid fire, explosions, electrocution, injury or death. Plugs and receptacles for different systems are designed in non-interchangeable configurations. A plug from one system cannot fit another system. Do not modify a shore power cable. Use only commercially available adapters for system modification. Ventilate the boat interior by opening the deck hatches, windows and cabin door to provide adequate ventilation.

The shore power system requires a special, marine grade, three-conductor cable to make a proper connection to the shore. Dockside connections and the boat side connections are plug-in. Boat side connections are also locked in position with a threaded locking collar to prevent accidental disconnection and enhance water resistance. The shore power connection is located at the port aft of your yacht. Make sure the shore power connection covers are in place and the access hatch is closed when the shore power connection is not in use.

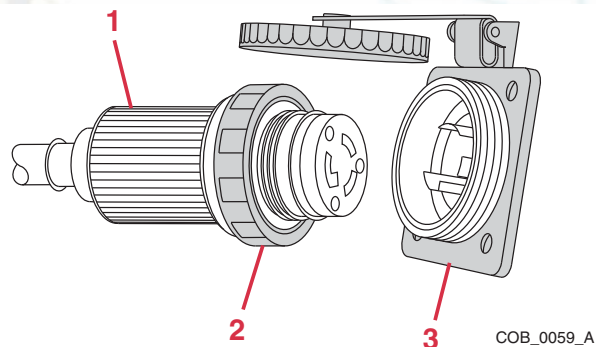

- 1 – Shore power cord
- 2 – Threaded locking collar
- 3 – Boat receptacle

COB_0059_A



To connect:

1. If the outlet on the pier has a disconnect switch, turn the switch off.
2. Connect the shore power cable at the yacht first.
3. Make sure the cable has more slack than the mooring lines.
4. Remove the cap from the outlet on the pier. Connect the cable to the outlet.
5. The inlet breaker is located in the engine compartment port aft transom. Normally, this is left on at all times.
6. Set the shore disconnect switch in the ON position.
7. If the reverse polarity indicator on the cabin 10" display is red, immediately disconnect the cable from the shore outlet and see your authorized Cobalt dealer.

To disconnect:

1. If the shore outlet has a disconnect switch, turn it to the OFF position.
2. Disconnect the shore power cord at the shore outlet.
3. Retract cable and close cap.

DANGER

Avoid fire, explosions, electrocution, injury or death. Some marinas have been known to “break” shore power ground circuits to prevent electrolysis. Opening the ground circuit creates a potentially dangerous onboard shock hazard. Use caution when using a “break” shore power ground circuit. If reverse polarity light is activated, immediately disconnect shore power cable.

Generator

DANGER

Avoid the possibility of injury or death from exposure to carbon monoxide (CO), fire or explosion, or electrocution.

- **Ventilate the boat interior by opening the deck hatches, windows and cabin door to provide adequate ventilation.**
- **Regularly inspect the engine and generator exhaust system for proper operation.**
- **Use the electrical system properly.**
- **If reverse polarity light is activated, immediately disconnect shore power cable.**

The generator is located in the engine compartment. The generator is used to provide AC power when shore power is not available. The generator uses fuel from the engine fuel system and also produces carbon monoxide gas (CO).

A controller mounted on the generator contains a Start/Stop switch, hour meter and a main output AC circuit breaker.



Your yacht has a remote start and stop switch for the generator located at the helm or on the cabin 10" display.

1. Make sure the generator seacock (located forward of the engines) is open.
2. Verify the selector switch is in the ON position on generator.
3. Make sure the AC Circuit Breakers, located on the Controller, are on.
4. Make the selection for the generator at the 10" display.
5. Start the generator following the manufacturer's instructions. Allow generator to operate for at least one minute to stabilize voltage.



NOTICE: There will be a delay of up to 20 seconds for the generator starter to engage when the start switch is depressed.

6. Make sure the 10" display shows Gen on.
7. Make sure the Gen breaker is activated on the E-Plex System panel behind the salon seat.
8. Switch the main AC circuit breakers on and then the respective circuits as needed.

FRESH WATER

The freshwater system provides potable (drinkable) water for the entire freshwater system. Refer to *Section 1, Specifications*, for the capacity of the water system.

The system is operated by a 12V DC water pump located in the salon bilge. It is necessary for the 12V DC system to be energized and the WATER PRESSURE switch to be turned on to operate the water system.

The water pump works on demand. It will not automatically shut off when the freshwater tank is empty. Monitor the level of water in the tank. If the water pump is allowed to run continuously, it may overheat.

To clean the water tank, refer to *Section 6, Water Systems*.

Consult your authorized Cobalt dealer for winterization requirements.

Water Level Indicator

The tanks level indicator display on the cabin 10" display will show the level of fresh water and waste in the tanks.

MARINE TOILET (HEAD) AND MACERATOR



NOTICE: Overboard discharge of waste water should only be used in approved areas. It is your responsibility to comply with local regulations regarding the discharge of waste. You could be fined if your boat has an operable overboard discharge system.

The macerator system allows the discharging of waste water directly overboard through a seacock in the engine room. The seacock valve must be opened to allow activation of the macerator pump switch located on the cabin 10" display. For additional operating information, refer to the macerator operator's manual supplied with your Cobalt yacht.



HEATING, VENTILATION AND AIR CONDITIONING

The Heating, Ventilation and Air Conditioning (HVAC) system supplies both heating and cooling to the cabin and cockpit using a heating and cooling pump system, and operates on 110V AC supplied by shore power or the generator. The system is controlled by the cabin 10" display located in the galley area or the respective touch pads.

The system must be properly winterized for storage to prevent damage. For additional information, contact your authorized Cobalt dealer.

1. Open the seacock in the engine compartment (normally left open).
2. Select "HVAC" on the cabin 10" display.
3. Select the area you desire to heat or cool by using "Mode" to turn the system on and "Fan" to adjust the air flow.
4. Use "Warmer" and "Cooler" to set the desired temperature. "Set" will display your set temperature.

COCKPIT ENCLOSURE

The side curtains and stern curtains attach to the top and deck.

Note: Glass will shrink slightly when it is cold and will also hold its shape when it is stored rolled or folded; allow glass to hang and warm up before installation.

1. Insert visors and side valances. Make sure valance is centered.
2. Zip all curtains to valances. Zip about five inches at a time for easier zipping. If visors are too tight, unzip top zipper while securing snaps.
3. Snap curtains to windshield.
4. Zip enclosures completely.
5. Make sure Velcro® is overlapped to help sealing.

Attach the aft curtains in the same manner.

Always roll the curtains instead of folding when storing. Do not use the enclosure for storage. These are for short-term storage and not designed for long-term storage, and will not provide adequate ventilation to prevent mold or mildew from forming. Refer to *Section 5, Interior and Exterior Care*, for information on care. For long-term storage, see your authorized Cobalt dealer.

TIE DOWN LOCATIONS

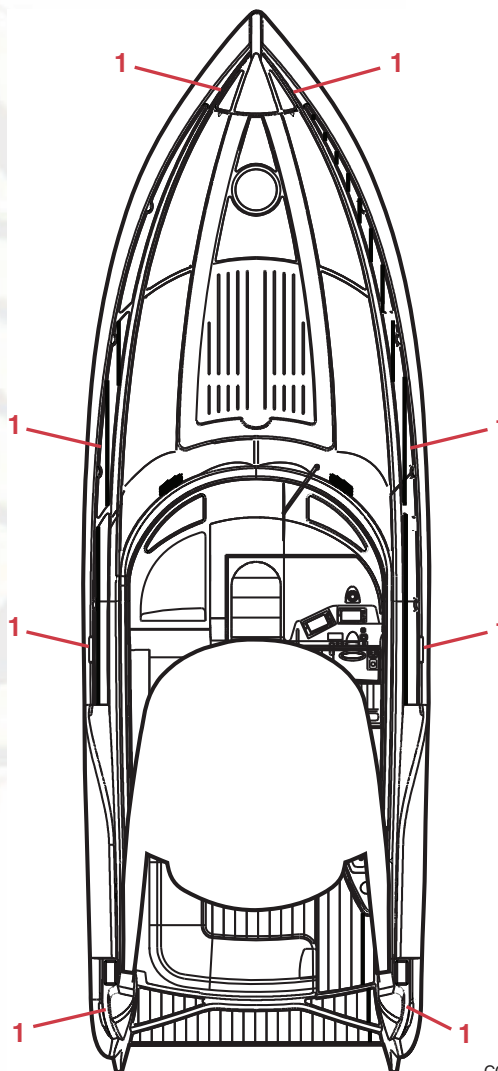

1 – Cleats

COB_0205_A



WARNING

Avoid injury, death or property damage. Never anchor a boat from the stern, and keep the boat headed into the waves.



NOTICE: Only use properly positioned slings to lift your boat.

Tie down locations are for keeping your Cobalt boat secured when moored. Refer to *Section 3, Anchoring*.

ENGINE HATCH ASSEMBLY

DANGER

To avoid injury or death, do not occupy or operate the engine(s) when the engine hatch is open. The engine hatch assembly is a machinery guard.

The electric engine hatch assembly is controlled by the **↑HATCH / ↓HATCH** switch at the helm. The positioning of the transom door will prevent the activation of the engine hatch switch. The engine hatch switch will not work unless the transom door is open. If the battery is low or disconnected, the bilge area can be accessed through the day hatch located in the aft cockpit. Use this entry hatch as to restore power to the 12 V DC system.

Do not operate the engine hatch assembly with any obstructions that will interfere with its operation, including canvas disconnect stern curtain, removal of side flaps and transom door locked in the open position. Damage to the engine hatch, hinges and lifting unit can result. Before opening the engine hatch, make sure no items are on top of it and any cushions, inserts or stored equipment are secure or removed. Wind and other conditions may allow the engine hatch to open beyond its limits. Use caution during these conditions.



SYSTEMS

INTRODUCTION

This section discusses the mechanical, electronic, and manual operating systems of your Cobalt boat. It describes basic operating characteristics and provides information for efficient use of the equipment, and for prevention of casualties. Be sure to read and understand all information provided before operating its systems.

WARNING

Avoid injury, death or damage to equipment. Regularly inspect and maintain all systems to prevent unexpected hazards associated with worn or faulty components. Be sure to replace system components and hardware with marine grade parts, not automotive components.

FUEL ROUTING

⚠ WARNING
 Avoid fire or explosion. Check the fuel system before each operation. At least once a year, have it checked by a certified Cobalt service technician.

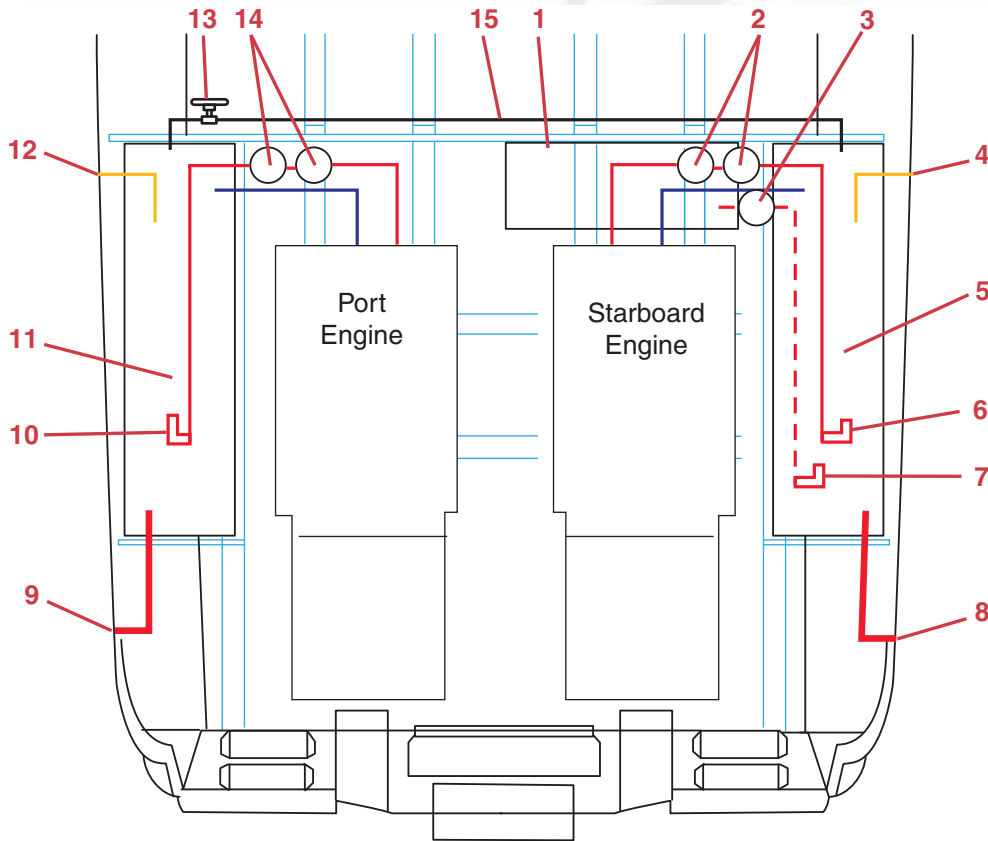

- Fuel line from tank
- Fuel fill line
- - - Generator fuel line
- Fuel line return
- Fuel vent

COB_0209_A

- | | |
|--|--|
| <ul style="list-style-type: none"> 1 – Generator 2 – Starboard Fuel Separator (Dual Racor Option) 3 – Generator Fuel Separator 4 – Starboard Fuel Tank Vent 5 – Starboard Fuel Tank 6 – Starboard Fuel Shut-Off Valve 7 – Generator Fuel Shut-Off Valve | <ul style="list-style-type: none"> 8 – Starboard Fuel Fill 9 – Port Fuel Fill 10 – Port Fuel Shut-Off Valve 11 – Port Fuel Tank 12 – Port Fuel Tank Vent 13 – Crossover Shutoff Valve 14 – Port Fuel Separator (Dual Racor Option) 15 – Crossover Line |
|--|--|



WATER SYSTEM

Fresh Water, Raw Water, City Waterline

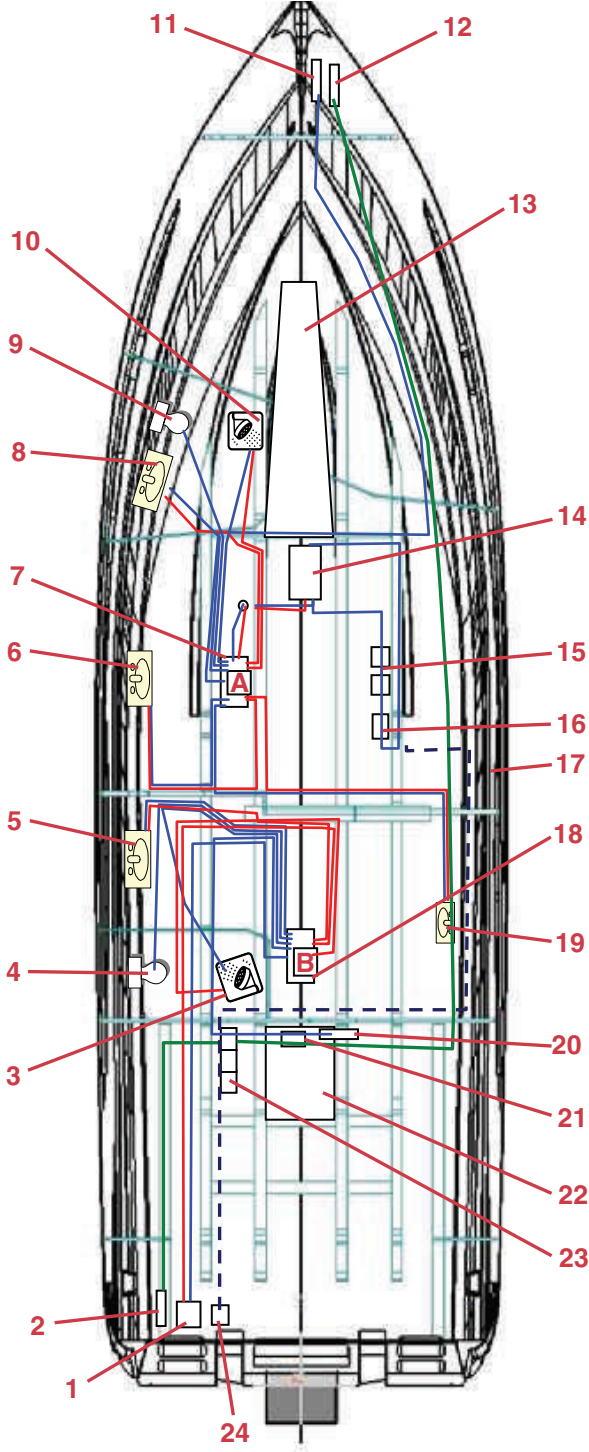

- 1 - TRANSOM WASHDOWN (hot-cold)
- 2 - RAW WATER WASHDOWN (option)
- 3 - AFT HEAD SHOWER (hot-cold)
- 4 - AFT HEAD TOILET (cold)
- 5 - AFT VANITY SINK (hot-cold)
- 6 - GALLEY SINK (hot-cold)
- 7 - FWD WATER DISTRIBUTION MANIFOLD (freshwater)
- 8 - FWD HEAD SINK (hot-cold)
- 9 - FWD HEAD TOILET (cold)
- 10 - FWD HEAD SHOWER (hot-cold)
- 11 - BOW WASHDOWN (cold)
- 12 - RAW WATER WASHDOWN
- 13 - FRESHWATER TANK - 100 gal (378.5 l)
- 14 - WATER HEATER -10-1/2 gal. (39.8 l)
- 15 - FRESHWATER FILTERS
- 16 - FRESHWATER PUMP
- 17 - FRESHWATER FILL DECK PLTAE
- 18 - AFT WATER DISTRIBUTION MANIFOLD (freshwater)
- 19 - COCKPIT SINK (hot-cold)
- 20 - ENGINE ROOM WASHDOWN (cold)
- 21 - WASTE OVERBOARD DISCHARGE PUMP (option)
- 22 - WASTE TANK
- 23 - RAW WATER PICKUP/STRAINER/PUMP
- 24 - CITY WATER INLET

- LEGEND:**
- COLD WATERLINE
 - HOT WATERLINE
 - RAW WATERLINE
 - - - CITY WATERLINE





COB_0211_A

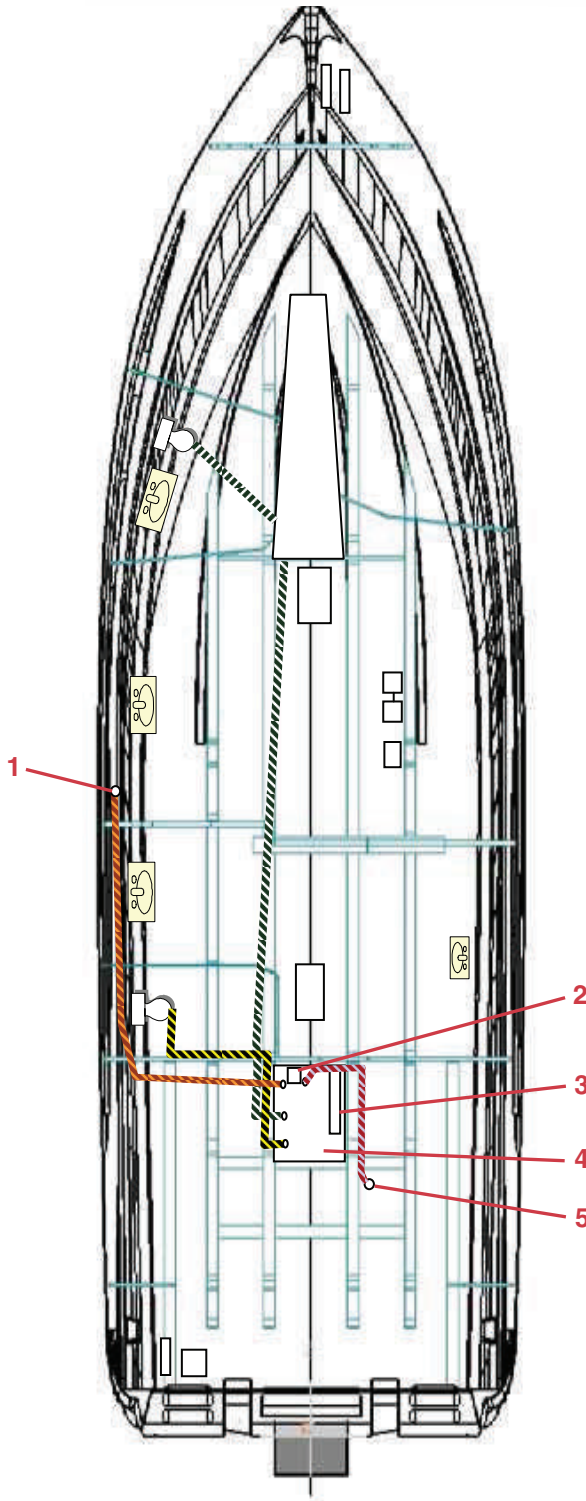

Waste



- 1 – WASTE DECK PLATE
- 2 – WASTE OVERBOARD DISCHARGE PUMP (option)
- 3 – WASTE TANK SANI GUARD/VENT
- 4 – WASTE TANK
- 5 – WASTE OVERBOARD DISCHARGE SEACOCK (option)

-  FWD HEAD WASTE HOSE
-  AFT HEAD WASTE HOSE
-  DECKPLATE PUMP-OUT HOSE
-  OPT. OVERBOARD DISCHARGE HOSE

COB_0212_A



Waste with Gray Water Option

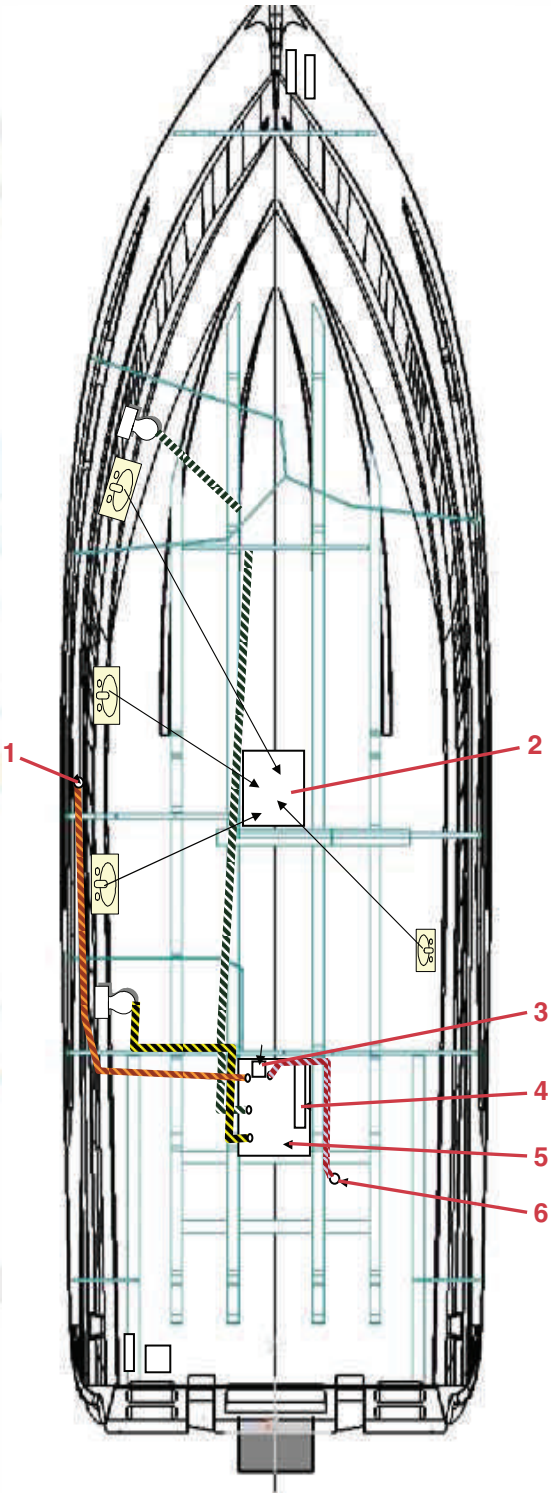

- 1 - WASTE DECK PLATE
- 2 - GRAY WATER TANK (option)
- 3 - WASTE OVERBOARD DISCHARGE PUMP (option)
- 4 - WASTE TANK SANI GUARD/VENT
- 5 - WASTE TANK
- 6 - WASTE OVERBOARD DISCHARGE SEACOCK (option)

-  FWD HEAD WASTE HOSE
-  AFT HEAD WASTE HOSE
-  DECKPLATE PUMP-OUT HOSE
-  OPT. OVERBOARD DISCHARGE HOSE



Bilge Layout

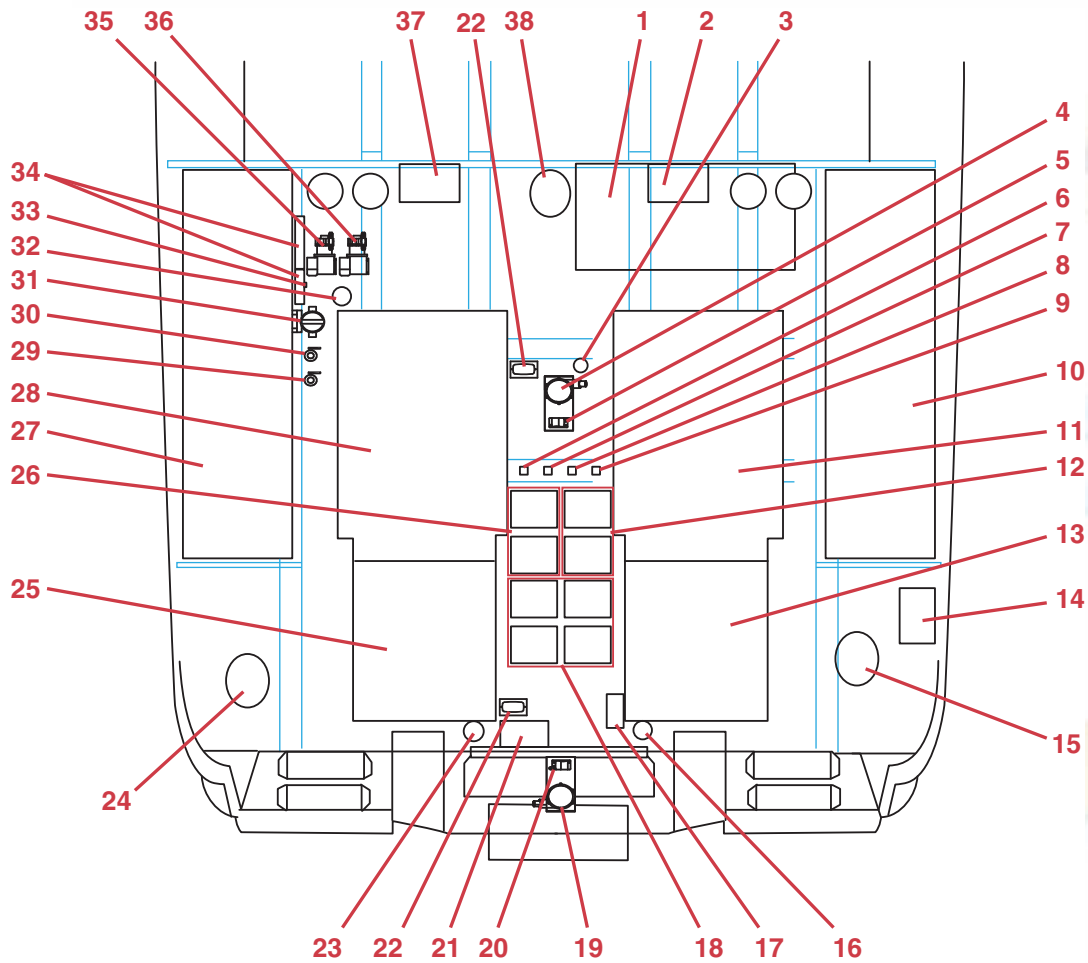

COB_0210_A

- | | |
|---|--|
| 1 – Generator | 20 – Aft Bilge Area Bilge Float Switch |
| 2 – Starboard Engine QSD Vessel Interface | 21 – Swim Platform Lift Pump |
| 3 – Generator Strainer | 22 – High Water Alarm |
| 4 – Forward Bilge Area Bilge Pump | 23 – Port Engine Strainer |
| 5 – Forward Bilge Float Switch | 24 – Port Muffler |
| 6 – Port Battery Switch | 25 – Port Engine Drive |
| 7 – Port VSR | 26 – Port Battery Bank |
| 8 – Starboard Battery Switch | 27 – Port Engine Fuel Tank |
| 9 – Starboard VSR | 28 – Port Engine |
| 10 – Starboard Engine Fuel Tank | 29 – Raw Water Seacock |
| 11 – Starboard Engine | 30 – HVAC Seacock |
| 12 – Starboard Battery Bank | 31 – HVAC Strainer |
| 13 – Starboard Engine Drive | 32 – Raw Water Strainer |
| 14 – Water Separator/Generator Exhaust | 33 – House Battery Switch |
| 15 – Starboard Engine Muffler | 34 – E-Plex DC Distribution |
| 16 – Starboard Engine Strainer | 35 – Raw Water Washdown Pump |
| 17 – Oil Change System | 36 – HVAC Cooling Pump |
| 18 – House Battery Bank | 37 – Port Engine QSD Vessel Interface |
| 19 – Aft Bilge Area Bilge Pump | 38 – Halon Automatic Fire Extinguisher |



Water System

Your Cobalt yacht is equipped with a water system which allows for fresh water to be onboard. A 12-volt DC water pump operates the system. It is necessary to supply power to the pump before it can be operated.

To operate the water system:

1. Select “TANKS” on the E-Plex menu.
2. Select “Freshwater Pump.” The fresh water, gray water and black water levels will also display.

Consult your authorized Cobalt dealer for winterization requirements.

To clean the water tank, add 1/4 cup of baking soda per 10 gallons of fresh water into the tank and allow it to stand in the tank for one day; then flush the tank twice. If this is not sufficient to clean the tank, replace the baking soda with 2 tablespoons of bleach per 10 gallons of fresh water and repeat the procedure. Refer to *Section 1, Specifications*, for freshwater capacity.

FIRE SUPPRESSION EQUIPMENT

Your Cobalt yacht is equipped with a fixed automatic fire extinguisher that uses FE-241 (or optional FM-200, for European requirements) as an extinguishing agent; it is mounted on the engine compartment and generator compartment (if equipped). These extinguishers are activated when the heat-sensitive head reaches a predetermined temperature. The extinguisher discharges and saturates the engine and/or generator compartment, smothering the fire.

Inspect fire extinguishers for proper charge before operating the yacht.

WARNING

Avoid injury, death or explosion. DO NOT open the engine compartment hatch immediately. This will allow oxygen to the fire, and flashback can occur. When the fire extinguisher discharge occurs, turn off all engines, bilge blowers and electrical system components.

ELECTRICAL SYSTEMS

Your Cobalt yacht is equipped with two electrical systems; battery powered direct current (DC) system, shore power and a generator which supplies alternating current (AC). These systems have a load center panel and the E-Plex system which serves as the main power distribution panel. The DC system supplies electricity to all of the 12V electrical circuits of the yacht (lights, pumps, blowers, ignition, etc.)

The AC system supplies 110V AC power to the electrical outlets and to AC-powered systems when the yacht is moored to dock or slip. Refer to *Section 3, Cabin Distribution Panel*.

DANGER

Avoid fire or explosions, or electrocution. These situations can occur from improper use of AC and DC systems. Do not work on an energized system. Use caution when connecting or disconnecting to shore power. Avoid swimming near the boat when it is connected to shore power.



BATTERY CONNECTIONS

WARNING

Avoid the potential of explosion from shorting or arcing. Keep the battery connections tight and clean, the terminal covers in place and the battery(ies) secure in the restraint system.

Loose battery connections can cause errant signals to the boat's electrical system.

Read and understand the safety information on or supplied with your battery(ies). Maintain the battery(ies) following the manufacturer's recommendations.

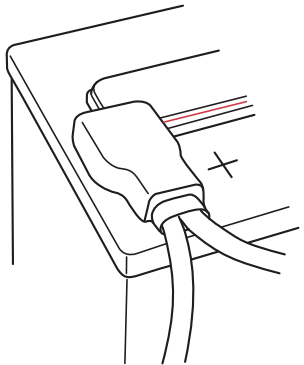



INTERIOR/EXTERIOR CARE

The best way to take care of your Cobalt yacht is with prevention and proper care. All of the care methods within this section may not apply to your boat.

VINYL INTERIOR AND UPHOLSTERY

The vinyl and interior fabric in your Cobalt yacht has been specially selected to take the tough punishment of the elements and hard usage of an active boater. Avoid sharp objects that may cut or tear your vinyl.

The vinyl in your Cobalt yacht has been coated with PreFixx protective finish. It is designed to be cleaned easily, over and over, without showing signs of wear. With PreFixx protection, it is possible to remove stains that could never be removed before. There are three families of sunscreen ingredients which may contribute to the staining of the vinyl in your Cobalt yacht.

- Aminobenzoic acids - e.g. PABA
- Hydroxy benzophenones - e.g. Oxybenzone
- P-methoxycinnamic acid - e.g. Octylmethoxycinnamate

This list should not be considered inclusive, although it does represent a large selection of sunscreens which are known to stain vinyls, even those treated with PreFixx. In actuality, almost any sunscreen with a high percentage - two percent or above - of active ingredients is a potential stainer.

The vinyl manufacturer or Cobalt Yachts warranties do not cover vinyl staining from suntan lotions.

Special care should be taken to prevent dark colored rubber products or Sunbrella™ canvas from coming in contact with the vinyl upholstery.

Care and Cleaning of Vinyl

Remove ordinary dirt and smudges with a mild soap and warm water solution. Dry with a soft, lint-free cloth or towel. For more difficult stains, use a stronger detergent. Follow the detergent manufacturer's instructions closely.

Special Cleaning Problems

The following steps are recommended to clean stains on PreFixx-protected vinyl upholstery. Many difficult stains can be removed when these cleaning agents are used in the following order.

Step 1 Cleaners

Rinse cleansed area with fresh water and dry with a clean cloth.

- Formula 409® or Fantastik®
- Clorox® Soft Scrub® with bleach
- Household cleaners and bleaches

Step 2 Cleaners

Solvent-type cleaners to be liberally applied with a cloth, damp sponge or fine bristle brush. Rinse cleansed area with fresh water and dry with a clean cloth.

- Rubbing alcohol (isopropyl alcohol)
- Lighter fluid (naphtha)



Step 3 Cleaners

Strong, active cleaners should be applied with a soft cloth or damp sponge. Use no more than six rubs, and if the stain persists, contact Cobalt Customer Service. Dry with another cloth, then rinse with clear water and dry.

- Nail polish remover (acetone/water)



NOTICE: It is extremely important to clean the stained area as quickly as possible, making sure the recommended cleaning steps are followed in order.

Recommended Cleaning Solutions for PreFixx-Coated Nautolex Vinyls

Staining Agent	Cleaning Step
Spray paint	1 - 2 - 3
Ballpoint pen	1 - 2 - 3
Lipstick	1 - 2 - 3
Yellow mustard	1 - 2 - 3
Bird droppings	1 - 2 - 3
Crayons	1 - 2
Eye shadow	1 - 2
Oily spot	1 - 2
Petroleum products	1 - 2
Coffee	1
Tea	1
Hair oil tonic	1
Blood	1
Urine	1
Grape juice	1
Olive oil	1
Chocolate	1
Ketchup	1
Baby oil	1

⚠ DANGER

Avoid fire or explosion. Avoid open flame or spark. Flammable liquids are extremely dangerous and must be used in well-ventilated areas.

Dark Stowage Areas

Often, when a boat is stored completely covered or in a dark building, the vinyl will darken or become “dingy” looking. If this happens, simply place the boat in direct sunlight for a few hours and the vinyl will brighten up.

Leather Care

For spots and spills, wipe up excess liquid immediately with a clean absorbent cloth or sponge. If necessary, use clean lukewarm water only and let air dry naturally. If water is used, clean the entire area where the spot occurred. For example, clean the entire seat cushion or entire arm. Do not dry wet areas with hair dryers.

For stubborn spots and stains, use a mild non-detergent cleaner such as a bar of Ivory Soap™ or Amway™ L.O.C. Apply the soap to a clean, wet sponge, wash, then rinse well. Let air dry naturally.

For butter, oil or grease, wipe any excess off the leather with a clean dry cloth, then leave it alone; the spot should dissipate into the leather in a short period of time. Do not apply water or try to wash a butter, oil or grease spot.



NOTICE: DO NOT use saddle soap, cleaning solvents, furniture polish, oils, varnish, abrasive cleaners, soaps or ammonia water.



CABINETY AND WOOD

Cabinetry

Your Cobalt yacht is equipped with exotic woods which require occasional care to maintain their natural beauty and high-gloss sheen. Clean with any water-rinseable non-abrasive cleaner.

- For routine cleaning, wipe the wood surface with a damp, soft cotton cloth. For thorough cleaning, use a glass cleaner and dry with a soft cotton cloth.
- Do not use cleaners or polishes containing abrasives, oily emollients or petroleum-based materials.

Teak Swim Platform

Your Cobalt yacht features teak and may be equipped with a teak swim platform or teak floors. To keep teak in top condition, clean it occasionally with a teak cleaner and re-oil it at least once a season. Interior teak may not have to be treated as frequently. Follow the manufacturer's instructions and warnings carefully. Some cleaners and oils may damage gelcoat, vinyl, stainless or aluminum. Avoid using rust-producing steel wool pads when cleaning. Materials can be purchased from your authorized Cobalt dealer.



NOTICE: Teak sealers and cleaners can be harmful to other materials. Make sure you thoroughly remove any spills or excess. Teak should not be varnished. The natural oils in teak will cause poor adhesion.

DANGER

Avoid fire or explosion onboard. DO NOT store rags used to treat teak onboard. Store or dispose of rags properly ashore.

Cedar

Wipe surface with a dry cloth or a slightly damp cloth. Do not seal or paint cedar.

CARPET

Vacuum the carpet on a regular basis. Use household carpet stain removers and cleaners to clean the carpet.

DECK AND HULL

The finish on your Cobalt yacht is known as gelcoat. The gelcoat used by Cobalt Yachts is the finest available on the market today. With all its properties, it is not impervious to the elements and many types of water conditions.

Cleaning Deck and Hull

A multi-purpose boat soap* should be used to clean exterior fiberglass/gelcoat surfaces on your Cobalt yacht after each use. This product, depending upon the ratio mixed, is designed to clean anything from dirty hulls and decks to greasy engines. Always rinse and wipe off the finish with a damp towel or chamois.

A fiberglass restorer/wax* should be used to remove heavy oxidation, characterized by a chalk/faded surface as well as rust and exhaust stains. This product will not only remove the oxidation, but also leaves a wax protection on the cleaned surface in one easy application.

* 3M carries a complete line of fiberglass care products.



Deck and Hull Care

Paste wax* will help retard UV light damage. We suggest three coats be applied at the end or the beginning of the season, depending on the type of winter boat storage (covered, enclosed storage facility), and again mid-season.

To extend the life of your gelcoat finish, use a high quality cover to totally cover the top deck of the yacht for maximum protection. Additionally, if your yacht is to be stored where the sun is constantly on the side or transom of the yacht, you should consider having some custom skirting made to complement the cover. Having your yacht professionally shrink wrapped can also provide maximum protection. Your Cobalt dealer may also have suggestions on the proper protection measures.

STAINLESS STEEL AND CHROME

Stainless steel, though highly resistant, is still capable of rusting, particularly in the marine environment. Initial signs of rust and corrosion, left untreated, may result in pitting and permanent damage to components. Keep your stainless steel looking new by cleaning monthly with a good quality stainless steel cleaner or polish.

The following steps will help protect against such occurrences:

Preventive Steps

Clean and wax metal brightwork prior to extended storage. In saltwater or other harsh environments, repeat more often as needed. High-quality stainless steel cleaners and conditioners are commercially available. Rinse with fresh water and wipe dry with towel or chamois after each use.

Cleaning Stainless Steel

Remove rust or corrosion promptly using a good metal cleaner/polish like Flitz. Delay may contribute to permanent finish damage. Do not use steel wool or other coarse abrasives, or clean with acids or bleach. DO NOT use cleaners that are not for use on stainless steel, such as glass, tile or counter cleaners, or citrus-based cleaners. These types of cleaners can damage the surface permanently. Apply metal or automotive wax after cleaning for additional protection. Always test any product in an inconspicuous area before applying to the complete surface.

Should you have reason to replace hardware or fasteners, be certain that replacements are correct materials. See your authorized Cobalt dealer for further information.

DANGER

Avoid fire, explosion or exposure to toxic materials. Some of these solvents are highly flammable and toxic. Exercise proper care in cleaning, wear protective gear and provide adequate ventilation. DO NOT store soiled rags onboard; store or dispose of rags properly ashore.

CAUTION

Use caution in cleaning around stitching, wood or other decorative trim, since these solvents could seriously damage these materials.

* 3M carries a complete line of fiberglass care products.



CORROSION PROTECTION

CorrosionX

One of the issues associated with owning a boat is corrosion, which, ironically, is often caused directly by the marine environment. If you operate a boat in salt water, you will be surprised by the excessive corrosion in just a few weeks. Since we recognize that your purchase of a Cobalt yacht was a major financial decision, we want you to be happy with your choice for years to come. After consulting with our dealers and operators throughout the country, we found that regular applications of a product called CorrosionX will keep your yacht operating at peak efficiency, free of corrosion. To assist you, we have included a small can of CorrosionX in the optional saltwater kit. Minimally, it should be applied to the following areas and components in the time frames specified:

Topside

Spray or wipe a light coat of CorrosionX on all rails, stanchions, cleats, cleat bolts and other metal fixtures/fittings up on deck. Treat hinges, locks, closure mechanisms and sliding tracks of doors and windows. If sprayed on, wipe with cloth to remove excess. A very light coat is all it takes and it should be applied every two months if operating in salt water and every four months in freshwater operations.

Inside the Bulkhead

Once a year, spray electrical connections, fuse panels and antenna bases. Light sockets should be treated at two- or three-month intervals. Every six months, treat plumbing connections in the galley and head areas. Once a year, apply to hinges, locks and sliding tracks of doors and windows to keep them properly lubricated and functioning smoothly.

Other Areas

Treat hydraulic cylinder shafts for steering and other operating mechanisms once a month. Spray the entire engine, including engine mounts, every six months. Treat the bilge pump housing and connections plus other items in the bilge area once every three months. Thru-hull fittings and seacocks should also be treated every three months. Fuel line fittings at the fuel tank should be treated every six months.

CorrosionX is a multi-functional product with universal application. A good rule of thumb: if it rusts or corrodes, if it needs lubricating or if it is rusted shut and needs to be broken apart, it is a potential application. If you have any questions about CorrosionX, check the manufacturer's web site:

<http://www.corrosionx.com> or call 800-638-7361.

Corrosion destroys underwater metal parts and can occur in fresh or salt water. Salt, brackish and polluted waters will accelerate corrosion.

Galvanic Corrosion

Galvanic corrosion (electrolysis) can result in serious damage to any metal component of your Cobalt yacht that is in the water. Galvanic corrosion is the deterioration of metals due to the effects of electrolytic action. When dissimilar metals are immersed in a conductive fluid such as salt water, an electric current is produced, similar to the action of a battery. The softest of the metals will be the first to become damaged.

Galvanic corrosion can occur in fresh or salt water; however, salt, brackish and polluted waters accelerate galvanic corrosion.

A self-sacrificing anode has been mounted to your Cobalt yacht to help prevent damage to metal components from galvanic corrosion. The anode will require frequent inspections. If the anode shows deterioration of 50% or more, it must be replaced for continued protection.



NOTICE: DO NOT paint an anode, its fasteners or its mounting surface. Painting will reduce the anode's corrosion protection capabilities. Make sure the anode's contact to its mounting surface is clean and secure.

Refer to the propulsion unit operator's manual for requirements on galvanic corrosion protection.

Saltwater

Wash the entire boat after each use in salt water. If you continue to operate in saltwater, the entire boat should be protected against saltwater damage as described in **Interior/Exterior Care**, in this section.

Refer to the propulsion unit operator's manual for manufacturer's saltwater operating recommendations.

SUNBRELLA® CANVAS

CAUTION

Avoid damage to the canvas. Under no circumstance are these fabrics to be put in hot water, run through the hot drying cycle of an automatic dryer or steam pressed at a dry cleaner. Fabric should be line-dried.

The canvas used on your Cobalt yacht is manufactured from top quality materials to provide you with years of trouble-free service.

The following information is provided to help you maintain the appearance and ease of operation.

Cobalt uses Sunbrella®, a woven fabric made of 100% solution-dyed acrylic fiber. It is very colorfast and will withstand long-term exposure to the sun (ultra-violet) without excessive fading or deterioration.

- Do not store canvas wet or in an unventilated, moist area.
- Always roll the canvas instead of folding.
- Roll the top carefully around the bows and cover with the storage boot provided.
- Your canvas is designed and intended for short-term use only. Do not use it for storage.

Cleaning Canvas

Canvas should be cleaned regularly before substances such as dirt and roof particles are allowed to accumulate on and become embedded in the fabric. The fabric can be cleaned without being removed from the installation. Simply brush off any debris, hose down and clean with a mild solution of natural soap in lukewarm water (no more than 100°F [37.8°C]). Rinse thoroughly to remove soap. **DO NOT USE DETERGENTS.** Allow to air dry. Do not store canvas wet or in an unventilated, moist area.

DO NOT use abrasive detergents and/or cleaners containing solvents or gasoline; these types will damage the fabric. If using high-pressure or steam-cleaning devices, use care; improper use can damage the vinyl coating and/or fabric.



Special Cleaning Problems

For heavily soiled fabric, remove the top from the frame. Soak the fabric for approximately 20 minutes in a solution that has been mixed to the following proportions:

- 1/2 cup (4 ounces) of non-chlorine bleach
- 1/4 cup of mild soap like Ivory Snow, Dreft™ or Woolite™
- One gallon of lukewarm water (water should be no more than 100°F [37.8°C])

Allow the fabric to soak until the non-chlorine bleach has killed the mildew and the stains can be brushed out with a soft scrub brush. Rinse the fabric thoroughly in cold water to remove all of the solution.

This may require rinsing several times. Incomplete rinsing can also cause deterioration of sewing threads and prohibit the fabric from being properly retreated. Do not soak excessively, since the non-chlorine bleach can deteriorate the sewing threads. Allow the fabric to air dry completely.

Sunbrella may also be dry cleaned. **DO NOT STEAM PRESS OR DRY IN AN ELECTRIC OR GAS DRYER.** Sunbrella is thermoplastic, or heat sensitive. Excessive heat can damage and shrink the fabric.

These methods of cleaning may remove part of the water and stain repellency that was applied to the fabric during its manufacture. The fabric should receive an application of an air curing treatment such as “303 HIGH TECH FABRIC GUARD” after it has been cleaned.

OTHER CANVAS COMPONENTS

Clear Vinyl “Strataglass”



NOTICE: Read and understand all Strataglass maintenance information to prevent damage to the glass.

We recommend using only IMAR Strataglass Protective Polish, IMAR Strataglass Protective Cleaner and mild soap (preferably IMAR Yacht Soap Concentrate) on Strataglass. Use of harsh cleaners such as Simple Green and/or pine will dull the curtains. Using any other product(s) voids the factory warranty. **NEVER** use a wash and wax product on Strataglass.



NOTICE: Use of RAINEX on Strataglass appears to work for a short time but then dulls the surface and presents an “Orange Peel” effect. Do not use RAINEX. Use of cleaners, polishes, scratch removers or any other product made for regular, uncoated vinyl will damage STRATAGLASS. Do not use these products. DO NOT handle Strataglass (or any vinyl) with sunscreen on your hands! This will permanently cloud the vinyl where handled.

General Maintenance

3M Adhesive Remover may be used to remove glue left from fabrication. Final clean with IMAR Strataglass Protective Cleaner. We recommend using IMAR Strataglass Protective Polish as the final step in installation to provide a base of protection and good watershed. We recommend using IMAR Strataglass Protective Polish every 1 to 2 months. In the interim, use IMAR Strataglass Protective Cleaner frequently.



NOTICE: All new vinyl can easily get impressions in itself. We recommend new enclosures be left in place to the extent possible. If completely removed, enclosures must be interleaved with either acid-free paper (available from framing shops) or old sheets (the best choice) to prevent “pooling” in the glass. Vinyl “seasons” over time and becomes less impressionable. Roll all curtains down and fasten in place nightly to keep perfect appearance. Refer to the manufacturer’s website for further information.

Cleaning

Wash the clear vinyl curtains whenever your boat is washed. To clean the clear vinyl curtains:

1. Flush thoroughly to cool the surface and rinse away environmental abrasives.
2. Wash the curtains with IMAR Yacht Soap Concentrate, or other equally gentle and high-quality soap.



NOTICE: Do not use Simple Green, pine or any other harsh cleaner; they will dull the surface.

3. Apply the soapy water to the clear vinyl section of the curtain with special purpose washing mitt or soft cotton cloths.
4. Thoroughly rinse the soapy solution with fresh water and completely dry the curtains with a high-quality chamois.
5. Apply IMAR Strataglass Protective Polish sparingly with small, light circular motions using a soft cotton cloth. Allow the polish to dry and then remove with a clean, soft cotton cloth.
6. Lightly buff to a sparkling shine.

For routine maintenance between polishing, use IMAR Strataglass Protective Cleaner. Ensure the clear vinyl panels are free of abrasives. Very lightly mist a soft cotton cloth. Lightly and briskly rub a manageable sized area and then lightly buff dry with another clean cloth. We recommend using IMAR Strataglass Cleaner at least weekly.

Zippers

When zippers are new, they can be more difficult to zip than when “used.” Zip carefully without forcing. They will loosen with use. Keep the zippers clean. A zipper lubricant may be used to help new zippers and to maintain long trouble-free service. The most vulnerable part of the zipper is where they start. Use care when starting zipper to prevent damage.

Lubricate the zippers periodically with a clear silicone spray. Spray silicone on the zipper and work the zipper back and forth.

Snap Fasteners

Fasteners should be unsnapped as close to the button as possible. Never remove canvas by pulling roughly on one edge of the material. This can damage the canvas and the fasteners. To prevent snaps from becoming difficult to unsnap, keep them clean and use lubricants such a small amount of Vaseline®, Chapstick®, WD-40®, silicone spray, etc. The most common recommendation is to rub candle wax or paraffin around the stud or inside the socket. Whichever method is used, make sure you clean up any excess so the lubricant does not stain the canvas or any other surfaces it may contact.

Replace any missing fasteners or fasteners that show signs of corrosion or damage.

Do not use petroleum based products, such as petroleum jelly.



WINDSHIELD

To keep the windshield clean, use a non-abrasive glass cleaner applied with a soft cloth. Do not use harsh detergents, solvents, chemicals or dry cloths. These items will scratch the surface.

BILGE

Keep the bilge area as clean as possible. Use a vacuum cleaner to remove debris from the bilge area. Oil and greasy dirt will accumulate over time and normally can be removed using soap and water. If necessary, consult your authorized Cobalt dealer for recommendations on special bilge cleaning and absorption products.

MARINE GROWTH

If marine growth is a problem in your boating area, it may be necessary to apply anti-fouling paint to the hull to slow growth and prevent gelcoat damage. Consult your authorized Cobalt dealer for recommendations.



NOTES





MAINTENANCE AND TROUBLESHOOTING

SCHEDULED MAINTENANCE AND SERVICE

Your Cobalt yacht may not include all of the features described in this section based on the options available and how your yacht was built. If you are in question of the features on your yacht, contact your authorized Cobalt dealer.

Maintenance Schedule

Use the checks and maintenance information outlined in the section along with service information contained within the individual component operator's manuals supplied with your boat. It is extremely important that you read and understand the periodic maintenance tasks outlined in your operator's manuals (propulsion unit, generator and other accessories) because those maintenance tasks are not repeated in this manual.

Use the following chart to establish your maintenance routine. Detailed information concerning the task is listed in this section.

Frequency	Task
Break-In	Refer to propulsion unit operator's manual and the generator operator's manual, if equipped.

Frequency	Task
Before Every Use	Test operation of carbon monoxide detectors.
	Check fluid levels.
	Check seacocks for leaks and ensure handles are secure.
	Check seawater strainers for leaks and accumulation of debris.
	Check generator's fuel/water separator, if equipped.
	Check exhaust system for leaks.
	Check fuel system for leaks.
	Check fire extinguisher.
	Check battery charge.
Every 50 Hours	Clean seawater strainers.
	Inspect propellers for damage.
Every 100 Hours	Clean bilge area.
Monthly	Test GFCI outlets.
	Check self-sacrificing anodes.
Quarterly	Have your authorized Cobalt dealer perform scheduled maintenance as outlined in this section.



Break-In

Careful break-in allows internal engine components to “seat” properly, resulting in maximum engine life and performance. Refer to the propulsion unit and generator operator’s manuals for manufacturers’ break-in requirements.

Before Each Use

See Boaters’ Checklist label at helm.

1. Test for proper operation of the carbon monoxide detector; refer to the carbon monoxide detector operator’s manual.
2. Check fluid levels of engines, transmissions, freshwater tank, waste holding tank and trim tab reservoir.
3. Check the air conditioning and generator seacocks and hoses for leaks. If you notice a leak, see your authorized Cobalt dealer.

CAUTION
<ul style="list-style-type: none"> • Seacocks can only be replaced when the boat is out of the water. • Make sure a seacock is in the CLOSED position before replacing a hose.

4. Check the air conditioning and generator seawater strainers for leaks and accumulation of debris.
 - If a hose is leaking or damaged, close the appropriate seacock. See your authorized Cobalt dealer for repairs.
 - If debris is seen within the container, close the appropriate seacock and remove the strainer cover. Lift strainer from container and thoroughly clean. If the container is full of sediment, remove the plug at the bottom of the container and allow water to drain into the bilge. Remove the container and clean any sediment. Install the container and plug. Install strainer in container and secure cover. Open the seacock and check for leaks.

CAUTION
Seacock must be in the CLOSED position before servicing a strainer.

5. Start engine and the generator. Check all exhaust systems for leaks. If you notice a leak, see your authorized Cobalt dealer.
6. Check all fuel lines and connections at fuel tanks, engines and the generator for leaks. If you detect a fuel leak, immediately see your authorized Cobalt dealer.

⚠ DANGER
Avoid the risk of fire or explosion. DO NOT operate your boat if a fuel leak is detected. All fuels are combustible. A fuel leak must be repaired before starting the engine or the generator.

7. Check the portable and automatic fire extinguishers for proper charge.
8. Check the battery charge of both engine batteries. Be sure that the batteries can start the engine(s) and the generator before proceeding on your cruise.

Every 50 Hours

1. Be sure to clean seawater strainers as described in **Before Each Use**, Step 3.
2. Check propellers for damage. If bends, cracks or other damage are found, consult your authorized Cobalt dealer for service. Do not continue to use badly damaged propellers. Using damaged propellers may damage the drive system within time.

Every 100 Hours

1. Clean the bilge area. Make sure all drain passageways are clear. Refer to **Bilge**, in this section, for cleaning instructions.

Monthly

1. Test the GFCI outlet circuit breaker feature of each GFCI outlet. Push the test button on each outlet. Power should be interrupted to all the outlets onboard. Press the reset button to restore power. If power is not interrupted, consult your authorized Cobalt dealer.

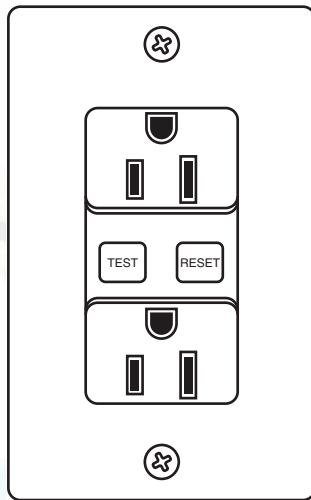

COB_0079_A



NOTICE: Outlets may not appear as shown.

2. Check condition of all self-sacrificing anodes. If anode shows deterioration of 50% or more, it must be replaced. Refer to the propulsion unit operator's manual for additional information.

Quarterly

Have your authorized Cobalt dealer perform the following scheduled maintenance:

1. Clean the freshwater filter.
2. Fill, pressurize and inspect the freshwater system for leaks and proper component operation.
3. Inspect the steering, shift and throttle systems for proper operation.
4. Check all batteries for proper electrolyte level.
5. Check all hydraulic pump fluid levels.

UNSCHEDULED MAINTENANCE

A problem with a piece of equipment can occur at any time. Be aware of a malfunction. Have a problem serviced immediately by your authorized Cobalt dealer.

Engine/Propulsion/Cooling System

If a problem occurs with your engine, propulsion unit or the cooling system between the scheduled maintenance cycle, immediately notify your authorized Cobalt dealer. Do not allow a problem to go unattended. By doing so, a minor repair could become a major overhaul.

Electrical System

Have your authorized Cobalt dealer repair all electrical problems. An electrical problem must be treated seriously.

DANGER

Avoid fire or explosion. Whenever checking for electrical problems, use extreme caution. Fuel and fumes are extremely flammable and explosive.

Fuel System

Do not operate your yacht knowing you have a fuel system problem. Upon discovery of a fuel system problem, immediately notify your authorized Cobalt dealer for repair.

WARNING

Avoid fire or explosion. Whenever checking for electrical problems, use extreme caution. Fuel and fumes are extremely flammable and explosive. DO NOT operate your boat when a fuel leak is detected. All fuels are combustible. A fuel leak must be repaired before starting the engine(s) or the generator (if equipped).

Water System

Fresh Water

Before departing on a cruise, check the level of fresh water onboard. Fill the freshwater tank and verify for proper operation of the freshwater system. If a problem is found, have the problem repaired at your earliest convenience.



Waste Water

Periodically check the level of waste water in the waste tank. Have your waste tank pumped out when needed and be sure that the waste system is always operating properly.

LIFTING THE YACHT

To prevent structural damage to your Cobalt yacht, the proper procedure must be used when lifting your boat. Only use appropriate style lifting slings to lift the boat. Slings must be used to lift the yacht.

Using Lifting Slings

The only recommended method of removing the boat from the water is to use lifting slings. Slings must be the flat, wide-belt type. Do not use cable-type slings. The spreader bars used with the slings must be wide enough to avoid pressure to the gunwales.

Your Cobalt yacht has sling location decals on each side of the hull to indicate where each sling should be located. Use the decals to position the slings.

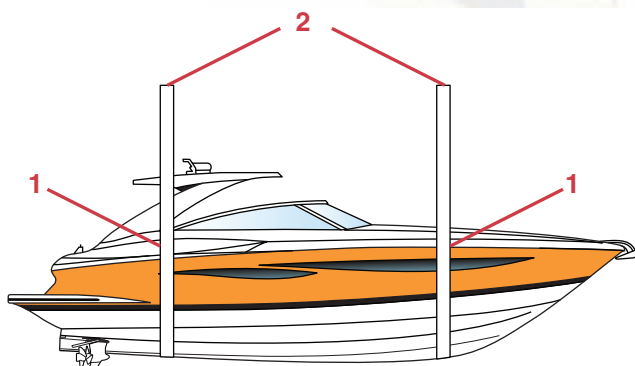

1 – Sling Tag Location
2 – Flat, Wide-belted Sling

Storage Cradle/Stand

Only use a storage cradle or stands designed for your yacht to store your yacht when it is not in the water. A storage cradle or stands for your yacht will provide proper support and prevent stress on the hull.

Position the storage cradle as close to the sling tag locations as possible. Use caution not to damage any underwater fittings.

The storage cradle must completely touch the hull for proper support. Avoid any gaps between the cradle and the hull.

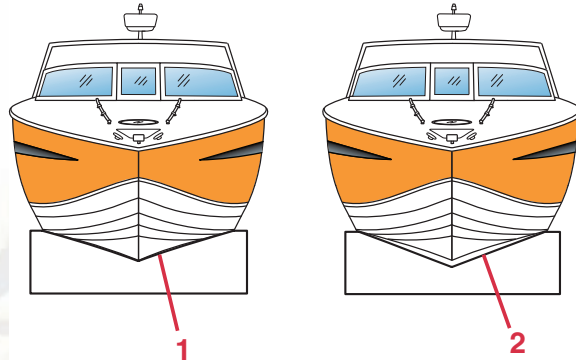

1 – Hull completely on cradle — correct
2 – Gap between hull and cradle — wrong

Store your Cobalt yacht on a storage cradle with the bow slightly elevated, the same attitude as if the boat were floating at rest. If the boat is stored with the bow down, moisture will not be able to move to the engine bilge area and out of the boat. Remove the transom drain plug.

Be sure that all compartments in the bilge completely drain. Mold and mildew may form as a result of the inability of moisture to escape.



STORAGE/WINTERIZATION

Preparing for winter lay-up is important. In frigid zones, be particularly attentive to items that can be damaged by freezing. Freeze damage is not covered by warranty.

The following items require special attention for winterization. Your Cobalt yacht may not include all the features described. Have your authorized Cobalt dealer perform winterization procedures for the following:

- Engine cooling and exhaust systems
- Fuel system
- Batteries
- Air conditioning and heating system
- Generator and muffler
- Waste water system
- Freshwater system
- Gray water system

After the yacht has been properly positioned on a storage cradle, thoroughly wash the hull, deck and interior compartments. Allow a couple of days of air drying before covering the yacht, store all cushions in the OPEN position and open all storage areas. This will help prevent mold/mildew from forming. Perform preventive maintenance to the interior and exterior of your yacht following the information in *Section 5, Interior and Exterior Care*.

Cover the yacht with a good quality cover. If a temporary poly cover, such as shrink wrap, is used, your authorized Cobalt dealer will install several vents to provide adequate ventilation to prevent mold or mildew.



NOTICE: For stowage, we recommend an optional mooring cover of 100% SharkSkin™ polyester. **DO NOT** use your tonneau cover for long term storage. These canvases were not designed for long term storage and do not provide good protection for your yacht. Adequate ventilation is not possible and mold/mildew will form.

For more information on appropriate covering for long term storage, see your authorized Cobalt dealer.

Reactivating the Yacht After Storage

Have your authorized Cobalt dealer prep your yacht for the upcoming boating season. There are many systems that require special attention to ensure your yacht is in proper operating condition.

- Carbon monoxide detector
- Fuel and exhaust systems
- Engine's cooling, exhaust and lubrication systems
- Air conditioning and heating system
- Generator and muffler
- Freshwater system
- Waste water system
- Gray water system
- Batteries

It is very important that all fuel systems and exhaust systems be thoroughly inspected and repaired, if necessary, before operating the yacht. Also, any accessory exhaust systems must be in proper operating condition.



DANGER

Avoid the risk of fire or explosion. Inspect the fuel system. Failure to inspect the fuel system and allow fuel leaks to go undetected will contribute to a fire or explosion hazard.

DANGER

Avoid the possibility of injury or death. Exposure to carbon monoxide (CO) can cause severe injury or death. All gasoline engines produce CO. CO is colorless, odorless and dangerous. Direct and prolonged exposure to CO will cause brain damage or death. Signs of exposure to CO include nausea, dizziness and drowsiness. Avoid exposing your passengers or yourself to carbon monoxide.

TROUBLESHOOTING

The following chart will assist you in locating and repairing a minor problem. Have your authorized Cobalt dealer assist you with service issues.

Your Cobalt yacht is equipped with many safety features. Make sure that all safety features are functioning correctly. The E-Plex system monitors and controls power distribution to your yacht. If a problem requires power from the E-Plex system, make sure it is powered. If you are experiencing any problems with any of the safety systems or the E-Plex system, contact your authorized Cobalt dealer.

DANGER

Avoid the risk of fire, explosion, electrocution or bodily injury. Fuels are extremely explosive and flammable. Use extreme caution when handling fuels.

- **Whenever checking for electrical problems use extreme caution.**
- **Battery acid can cause blindness if splashed in eyes, burning of skin. Wear protective gear.**
- **Disconnect battery cables at the battery before making checks or adjustments around the engines and electrical components.**



Engine

For further troubleshooting information other than given here, refer to the propulsion unit operator's manual.

Symptom	Possible Cause
Engine will not crank	Be sure red switch on battery switch is turned to OFF position and then to AUTO if controlling by E-Plex switches at dash. For manual override, turn red switch on battery switch to the ON position.
	Shift position – check to see that levers are in START or NEUTRAL position.
	Battery condition – verify batteries are fully charged.
	Starter connections – check connections and tighten. If solenoid clicks when attempting to start engine, check battery connections. If condition persists, see your authorized Cobalt dealer.
	Engine circuit breaker – verify breaker is in operating position.
	DC MAIN – be sure breakers or ignitions are on.
	Faulty ignition switch – see your authorized Cobalt dealer.
	Engine problem – see your authorized Cobalt dealer.
Engine cranks but will not start	Fuel valves – be sure fuel valves on tank and valves on fuel filters are open.
	Contaminated fuel – see your authorized Cobalt dealer.
	Engine problem – see your authorized Cobalt dealer.
Low starter speed	Weak or bad battery – see your authorized Cobalt dealer.
Engine runs erratically	Air in fuel lines – check fuel system and tighten all fuel fittings – see your authorized Cobalt dealer.
Engine vibrates	Propeller condition – shut off engines. Check for bent, broken or damaged propeller. Check for weeds on propeller.
	Engine problem – loose engine mounts or misaligned – see your authorized Cobalt dealer.
Engine runs but boat makes little or no progress	Fouled or damaged propeller – shut off engines. Check for weeds on propeller, bent or broken propeller. See your authorized Cobalt dealer.
Performance Loss	Throttles not fully open – check to see that both throttles open fully at engines.
	Improper fuel – fill tanks with correct fuel.
	Overheating – immediately turn off the engines and contact your authorized Cobalt dealer.
	Boat overloaded – reduce load.
	Boat trim – distribute boat load evenly.
	Improper propeller selection – see your authorized Cobalt dealer.
	Excessive bilge water – check for excessive water, drain bilge.
	Boat hull condition – clean if marine growth is present.



Electrical

CAUTION
Correct a problem with the electrical system before resetting a circuit breaker.

Symptom	Possible Cause
Electrical component will not function	Circuit breakers tripped or in the OFF position – correct the problem and reset; turn circuit breaker on.
Dim or no lights	Circuit breakers tripped or in the OFF position – correct the problem and reset; turn circuit breaker on.
	Battery discharged – charge battery.
Generator will not start	Power switch in the OFF position – turn power switch ON.
	Engine Problem – see your authorized Cobalt dealer.
No AC power	Circuit breakers tripped or in the OFF position – correct the problem and reset the shore power inlet breaker or the breaker on the cabin distribution panel.
	Make sure shore/generator selector switch is positioned correctly.
	Ground fault circuit interrupter tripped – reset button on the outlet and test. If problem exists – see your authorized Cobalt dealer.
Generator shuts down on its own	Remove all AC loads from generator. Make sure raw water seacock is open. Check fuel filter.

Plumbing

Symptom	Possible Cause
No water at sink	Freshwater pump circuit tripped or in the OFF position – correct the problem and reset on the 10" display.
	Freshwater tank empty.
	Freshwater pump defective – see your authorized Cobalt dealer.
	Filter plugged – clean filter located at the tank under mid-berth.
Low water pressure at sink	Make sure water filters are clean, or replace. Damaged freshwater pump, restriction or obstruction in waterline – see your authorized Cobalt dealer.
Head will not flush	No battery power or water pressure.
	Line to waste tank blocked – see your authorized Cobalt dealer.



REFERENCE AND FORMS

OPERATION QUICK REFERENCE

Your safety, the safety of your passengers and other boats are among your responsibilities as operator of the boat. Your boat must be in compliance with USCG safety equipment regulations.

Before Launching

If pulling from storage, de-winterize the engine(s); consult your authorized Cobalt dealer if necessary.

- Have enough PFDs for every person onboard.
- Make sure you have enough fuel.
- Verify the batteries are fully charged.
- Check all fluid levels. Refer to the propulsion unit operator's manual or consult your authorized Cobalt dealer.
- Check weather conditions.
- Be sure the lights, horn, bilge pumps and other electrical equipment are in operating conditions.
- Be sure the fire extinguisher, signaling devices and other emergency gear are onboard and in proper operating condition.

Pre-Operation

- Test operation of carbon monoxide detectors.
- Open all seacocks and check for leaks.
- Check seawater strainers for leaks and accumulation of debris.
- Check generator fuel/water separator.
- Open windows, doors and hatches.
- Check that no fuel, oil or water is leaking or has leaked into the bilge compartment.
- Check all hoses and connections for leakage and damage.
- Check that the steering system operates properly.
- Do not overload your boat.

Starting Engines

- Turn battery switches at dash to ON. Light will turn green.
- Make sure both shift levers are in the NEUTRAL position.
- Move throttle lever to the IDLE position. Turn on ignition switches in helm storage area.
- Start both engines by pressing start buttons on dash.

After engines are warmed up, verify water temperature is within its specified range.

Casting Off

- Allow enough room between the boat and the dock to swing the boat away from the dock.
- Retrieve all mooring lines and fenders.
- Proceed slowly and sound a long blast to alert other boaters you are leaving.

During Operation

- Check gauges frequently for signs of abnormal operation.
- Check for excessive vibration.
- Monitor your fuel supply.
- Verify charging of the batteries.

Returning to Port

- Come to a stop a short distance from the dock, then proceed slowly.
- Have your fenders, mooring lines and the crew ready.

Stopping the Engines

- Slowly bring the throttle levers to the IDLE position.
- Move the shift lever to the NEUTRAL position.
- Press stop buttons on dash.
- Turn the ignition keys to the OFF position and remove if leaving the vessel.

After Boating

- Turn off your navigational lights, leave the anchor light on, if necessary.
- Check the bilge for fumes and water. Operate the blower and bilge pump, if necessary.
- Fill fuel tanks to prevent moisture due to condensation.
- To prevent marine growth from accumulating on the hydraulic cylinder shafts, make sure trim tabs are up and propulsion unit drives are in the full IN position.
- Remove the ignition keys.
- Stow and secure all equipment.
- Pump bilges dry with manual switch.
- Close all water inlet seacocks.
- If possible, inspect the hull and propellers for damage.
- Check for fuel, oil and water leaks.
- Clean any spills, stains or moisture from the boat. Inspect sea strainers.
- Turn battery switches to the OFF position using switch at helm or 10" display in cabin (must press and hold for two seconds).
- Turn off E-Plex main power switch at distribution panel in cabin if vessel will not be used for three days or more and battery charging is not available.
- Remove any food, garbage and wet gear from the boat.
- Secure lockers, hatches and canvas as equipped.



FLOAT PLAN

Copy this page and fill out the copy before boating. Leave the filled out copy with a reliable person who can be depended upon to notify the USCG or other rescue organization, should you not return as scheduled. Do not file this plan with the USCG.

Name _____ Telephone _____

Description of Boat: Type _____ Color _____ Trim _____

Registration Number _____

Length _____ Length _____ Length _____

Other Info. _____

Persons Aboard: Name, Age, Address & Telephone

Engine Type: _____ HP _____

No. of Engines: _____ Fuel Capacity: _____

Survival Equipment:

PFDs _____ Flares _____ Mirror _____

Smoke Signals _____ Flashlight _____ Food _____

Paddles _____ Water _____ Anchor _____

Raft or Dinghy _____ EPIRB _____

Radio: Yes _____ No _____ Type _____ Freq _____

Destination _____ Est. Time of Arrival _____

Expect to Return By _____

Auto Type _____ License No. _____ Parked _____

If not returned by _____ call the Coast Guard, or _____

(Local Authority). Coast Guard Telephone Number: _____

Local Authority Telephone Number: _____



BOAT INFORMATION

Store this information in a safe place other than on your boat.

Owner _____

Home Port _____

Boat Name _____

Selling Dealer _____

Port Ignition Key Number _____ Starboard Ignition Key Number _____

Cabin Key Number _____

Registration Number _____ State _____

Hull Serial Number _____ Warranty Registration Date _____

Engine Make and Model Number _____

Port Engine Serial Number _____ Starboard Engine Serial Number _____

Port Drive Serial Number _____ Starboard Drive Serial Number _____

Propeller Size _____

Generator Model Number _____ Serial Number _____

VHF Radio Make and Model Number _____ Serial Number _____

GPS Make and Model Number _____ Serial Number _____

Radar Make and Model Number _____ Serial Number _____

DVD Make and Model Number _____ Serial Number _____

Stereo Make and Model Number _____ Serial Number _____

TV, Cabin Make and Model Number _____ Serial Number _____

TV, Mid-berth Make and Model Number _____ Serial Number _____

Subwoofer Make and Model Number _____ Serial Number _____





COBALT BOATS

Cobalt Boats
1715 North 8th Street
Neodesha, KS 66757
www.cobaltboats.com